

ACO SERIES

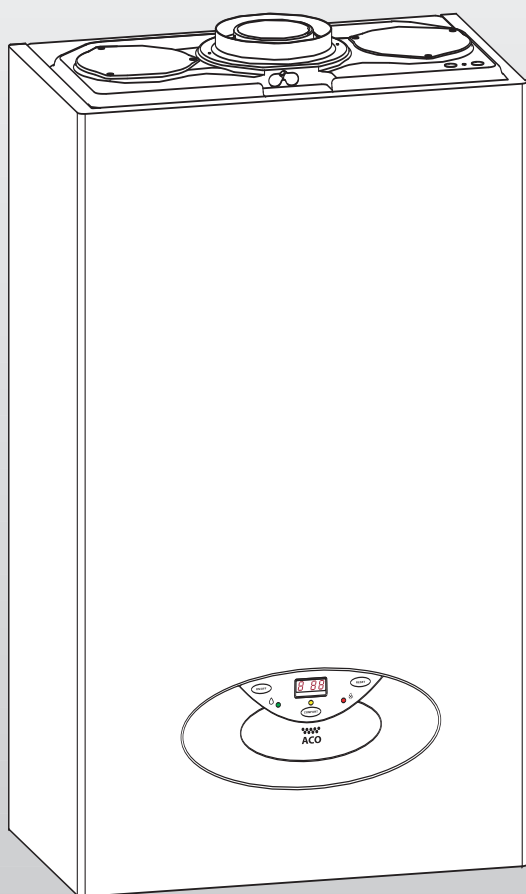

Installation and Servicing Instructions Type C Boilers

G.C.N: 47-116-34

G.C.N: 47-116-35

G.C.N: 47-116-09

G.C.N: 47-116-10

**LEAVE THESE
INSTRUCTIONS WITH THE
END-USER**



30002822026831E30 123040300000C

 **ARISTON**

CE

benchmarkTM
SOLUTIONS

The code of practice for the installation,
commissioning & servicing of central heating systems

Country of destination: GB/IE

TABLE OF CONTENTS

- 1. GENERAL INFORMATION**
 - 1.1. GENERAL INFORMATION
 - 1.2. TECHNICAL INFORMATION
 - 1.3. OVERALL VIEW
- 2. INSTALLATION**
 - 2.1. REFERENCE STANDARDS
 - 2.2. SITING THE APPLIANCE
 - 2.3. OVERALL DIMENSIONS
 - 2.4. MINIMUM CLEARANCES
 - 2.5. MOUNTING THE APPLIANCE
 - 2.6. ELECTRICAL CONNECTION
 - 2.7. GAS CONNECTION
 - 2.8. WATER CONNECTIONS
 - 2.9. FLUE CONNECTIONS
 - 2.10. ACCESSORY CONNECTION
 - 2.11. ELECTRICAL DIAGRAM
 - 2.12. WATER CIRCUIT DIAGRAM
- 3. COMMISSIONING**
 - 3.1. INITIAL PREPARATION
 - 3.2. REMOVING THE CASING
 - 3.3. CONTROL PANEL
 - 3.4. INITIAL START-UP
 - 3.5. DISPLAY: MESSAGES SHOWN DURING NORMAL OPERATION
 - 3.6. OPERATING PARAMETERS
 - 3.6.1. REGULATION MENU TABLE
 - 3.6.2. SETTINGS DISPLAY
 - 3.6.3. GAS REGULATION CHECK
 - 3.6.4. IGNITION DELAY ADJUSTMENT
 - 3.6.5. ADJUSTING THE MAXIMUM HEATING POWER
 - 3.6.6. SOFT LIGHT ADJUSTMENT
 - 3.7. CHANGING THE TYPE OF GAS
 - 3.8. BOILER SAFETY SYSTEMS
 - 3.9. COMBUSTION ANALYSIS
 - 3.10. COMPLETION
 - 3.11. DRAINING
- 4. ZONE VALVES**
- 5. MAINTENANCE**
 - 5.1. GENERAL REMARKS
 - 5.2. CLEANING THE PRIMARY EXCHANGER
 - 5.3. CLEANING THE CONDENSATE TRAP
 - 5.4. OPERATIONAL TEST
- 6. SERVICING INSTRUCTIONS**
 - 6.1. REPLACEMENT OF PARTS
 - 6.2. TO GAIN GENERAL ACCESS
 - 6.3. ACCESS TO THE COMBUSTION CHAMBER
 - 6.3.1. REMOVING THE FAN
 - 6.3.2. REMOVING THE AIR PRESSURE SWITCH
 - 6.3.3. REMOVING THE BURNER
 - 6.3.4. REMOVING THE ELECTRODES
 - 6.3.5. REMOVING THE HEAT EXCHANGER
 - 6.3.6. REMOVING THE CONDENSATE TRAP (TUBE)
 - 6.3.7. REMOVING THE CONDENSATE TRAP
 - 6.4. ACCESS TO THE GAS VALVE
 - 6.4.1. REMOVING THE GAS VALVE
 - 6.4.2. REMOVING THE SPARK GENERATOR
 - 6.5. ACCESS TO THE WATER CIRCUIT
 - 6.5.1. REMOVING THE D.H.W. (SECONDARY) EXCHANGER
 - 6.5.2. REMOVING THE SAFETY VALVE
 - 6.5.3. REMOVING THE AUTOMATIC AIR VENT
 - 6.5.4. REMOVING THE DIVERTER VALVE ACTUATOR
 - 6.5.5. REMOVING THE DHW FLOW SWITCH (MFFI ONLY)
 - 6.5.6. REMOVING THE PUMP
 - 6.5.7. REMOVING THE PRESSURE GAUGE
 - 6.5.8. REMOVING THE EXPANSION VESSEL
 - 6.5.9. REMOVING THE D.H.W. TEMPERATURE PROBE (N.T.C. - MFFI ONLY)
 - 6.5.10. REMOVING THE C.H. FLOW TEMPERATURE PROBE (N.T.C.)
 - 6.5.11. REMOVING THE C.H. RETURN TEMPERATURE PROBE (N.T.C.)
 - 6.6. ACCESS TO THE CONTROL SYSTEM
 - 6.6.1. CHECKING THE FUSES
 - 6.6.2. REMOVING THE PRINTED CIRCUIT BOARDS
 - 6.6.3. REMOVING THE TIME CLOCK
- 7. FAULT FINDING**
 - 7.1. FAULT FINDING GUIDE (FLOW-CHARTS)
- 8. SHORT SPARES PARTS LIST**
 - 8.1. ACO 27 MFFI

1. GENERAL INFORMATION

This manual is an integral and essential part of the product. It should be kept with the appliance so that it can be consulted by the user and our authorised personnel.

Please carefully read the instructions and notices about the unit contained in this manual, as they provide important information regarding the safe installation, use and maintenance of the product.

For operating instructions please consult the separate Users Manual.

1.1. GENERAL INFORMATION

Read the instructions and recommendations in these Installation and Servicing Instructions carefully to ensure proper installation, use and maintenance of the appliance.

Keep this manual in a safe place. You may need it for your own reference while Servicing Technicians or your installer may need to consult it in the future.

This is a combined appliance for the production of central heating (C.H.) and domestic hot water (D.H.W.).

This appliance **must be used only** for the purpose for which it is designed.

The manufacturer declines all liability for damage caused by improper or negligent use.

No asbestos or other hazardous materials have been used in the fabrication of this product.

Before connecting the appliance, check that the information shown on the data plate and the table in section 7 comply with the electric, water and gas mains of the property. You will find the data plate on the reverse of the control panel.

The gas with which this appliance operates is also shown on the label at the bottom of the boiler.

Do not install this appliance in a damp environment or close to equipment which spray water or other liquids.

Do not place objects on the appliance.

Do not allow children or inexperienced persons to use the appliance without supervision.

If you smell gas in the room, **do not turn on or off** light switches, use the telephone or any other object which might cause sparks.

Open doors and windows immediately to ventilate the room.

Shut the gas mains tap (at or adjacent to the gas meter) or the valve of the gas cylinder and call your Gas Supplier immediately. If you are going away for a long period of time, remember to shut the mains gas tap or the gas cylinder valve.

Always disconnect the appliance either by unplugging it from the mains or turning off the mains switch before cleaning the appliance or carrying out maintenance.

In the case of faults or failure, switch off the appliance and turn off the gas tap. Do not tamper with the appliance.

For repairs, call your local Authorised Servicing Agent and request the use of original spare parts. For in-guarantee repairs contact MTS (GB) Limited.

1.2. TECHNICAL INFORMATION

General Info	Name		ACO 27 MFFI	ACO 27 RFFI SYSTEM
	CE Certification		0085BP0229	0085BP0229
	Flue Type		C13-C33-C43-C53-C83-B23-B33	C13-C33-C43-C53-C83-B23-B33
Energy Performance	Heat Input max/min (Central Heating)	kW	25,5 / 8,9	25,5 / 8,9
	Heat Input max (Domestic Hot Water)	kW	27,0	-----
	Heat Output max/min	kW	22,5 / 7,7	22,5 / 7,7
	Efficiency of Nominal Heat Input (60/80°C)	%	88,2	88,2
	Efficiency of Nominal Heat Input (30/50°C)	%	88,2	88,2
	Efficiency at 30% of Nominal Heat Input (47°C)	%	92,9	92,9
	Efficiency at 30% of Nominal Heat Input (30°C)	%	92,9	92,9
	Efficiency at Minum Input	%	86,7	86,7
	Efficiency (Dir. 92/42/EEC)**		☆☆☆☆	☆☆☆☆
	SEDBUK Rating	Band	A	A
	Heat Loss to the Casing ($\Delta T=50^{\circ}\text{C}$)	%	0,5	0,5
	Flue Heat Loss with Burner Operating	%	2,6	2,6
Flue Heat Loss with Burner Off	%	0,4	0,4	
Emissions	Max Discharge of Products of Combustion (G20)	Kg/h	35,3	35,3
	Residual Discharge Head	mbar	0,61	0,61
	Temp. of exhaust fumes at nominal capacity	°C	72	72
	CO ₂ Content	%	9,1	9,1
	O ₂ Content	%	4,3	4,3
	CO Content	ppm	109	109
	Nox Class		5	5
Central Heating	Head Loss on Water Side (max) (T=20°C)	mbar	200	200
	Residual Head of System	bar	0,2	0,2
	Expansion Vessel Pre-load Pressure	bar	0,7	0,7
	Maximum Heating Pressure	bar	3	3
	Expansion Vessel Capacity	l	7	7
	Maximum Water Content of System	l	130	130
	Heating Temperature max/min (High temperature)	°C	82 / 42	82 / 42
Heating Temperature max/min (Low Temperature)	°C	75 / 20	75 / 20	
Domestic Hot Water	Domestic Hot Water Temperature (approx) max/min	°C	56 / 36	
	Specific Flow Rate (10 minutes/DT 30°C)	l/min	12,6	
	D.H.W. Flow Rate $\Delta T=25^{\circ}\text{C}$	l/min	15,2	
	D.H.W. Flow Rate $\Delta T=35^{\circ}\text{C}$	l/min	10,8	
	D.H.W. Minimum Flow Rate	l/min	2,5	
	Pressure of Domestic Hot Water max/min	bar	6 / 0,2	
Gas	Max. Condensate produced	l/h	1,5	1,5
	PH of condensate	W	4	4
	Nominal Pressure Natural Gas (G20)	mbar	20	20
Electrical Data	Consumption at Nominal Capacity(G20)	m ³ /h	2,43	2,43
	Gas Consumption after 10 Minutes*	m ³	0,85	0,85
	Electrical Supply	V/Hz	230/50	230/50
	Power Consumption	W	118	118
	Minimum Ambient Temperature	°C	+5	+5
Protection Grade of Electrical System	IP	24D	24D	
Internal Fuse Rating				
	Weight	Kg	40	40
	Dimensions (W/D/H)	mm	280/450/750	280/450/750
G.C. Number			47-116-34	47-116-09

* Calculated at 70% maximum output

** Calculated on Upper calorific value

General Info	Name		ACO 32 MFFI	ACO 32 RFFI SYSTEM
	CE Certification		0085BP0229	0085BP0229
	Flue Type		C13-C33-C43-C53-C83-B23-B33	C13-C33-C43-C53-C83-B23-B33
Energy Performance	Heat Input max/min (Central Heating)	kW	31,6 / 10,5	31,6 / 10,5
	Heat Input max (Domestic Hot Water)	kW	32,0	-----
	Heat Output max/min	kW	28 / 9,5	28 / 9,5
	Efficiency of Nominal Heat Input (60/80°C)	%	97,3	97,3
	Efficiency of Nominal Heat Input (30/50°C)	%	88,5	88,5
	Efficiency at 30% of Nominal Heat Input (47°C)	%	91,2	91,2
	Efficiency at 30% of Nominal Heat Input (30°C)	%	97,1	97,1
	Efficiency at Minum Input	%	89,7	89,7
	Efficiency (Dir. 92/42/EEC)**		☆☆☆☆	☆☆☆☆
	SEDBUK Rating	Band	A	A
Emissions	Heat Loss to the Casing (ΔT=50°C)	%	0,5	0,5
	Flue Heat Loss with Burner Operating	%	2,7	2,7
	Flue Heat Loss with Burner Off	%	0,4	0,4
	Max Discharge of Products of Combustion (G20)	Kg/h	45,7	45,7
Central Heating	Residual Discharge Head	mbar	1	1
	Temp. of exhaust fumes at nominal capacity	°C	76,4	76,4
	CO ₂ Content	%	8,7	8,7
	O ₂ Content	%	5	5
	CO Content	ppm	71	71
	Nox Class		5	5
Domestic Hot Water	Head Loss on Water Side (max) (T=20°C)	mbar	200	200
	Residual Head of System	bar	0,2	0,2
	Expansion Vessel Pre-load Pressure	bar	0,7	0,7
	Maximum Heating Pressure	bar	3	3
	Expansion Vessel Capacity	l	7	7
	Maximum Water Content of System	l	130	130
	Heating Temperature max/min (High temperature)	°C	82 / 42	82 / 42
	Heating Temperature max/min (Low Temperature)	°C	75 / 20	75 / 20
Gas	Domestic Hot Water Temperature (approx) max/min	°C	56 / 36	
	Specific Flow Rate (10 minutes/DT 30°C)	l/min	15,3	
	D.H.W. Flow Rate ΔT=25°C	l/min	18,3	
	D.H.W. Flow Rate ΔT=35°C	l/min	13,1	
	D.H.W. Minimum Flow Rate	l/min	2,5	
	Pressure of Domestic Hot Water max/min	bar	6 / 0,2	
Electrical Data	Max. Condensate produced	l/h	1,8	1,8
	PH of condensate	W	4	4
	Nominal Pressure Natural Gas (G20)	mbar	20	20
	Consumption at Nominal Capacity(G20)	m ³ /h	3,01	3,01
	Gas Consumption after 10 Minutes*	m ³	0,35	0,35
G.C. Number	Electrical Supply	V/Hz	230/50	230/50
	Power Consumption	W	118	118
	Minimum Ambient Temperature	°C	+5	+5
Weight	Protection Grade of Electrical System	IP	24D	24D
	Internal Fuse Rating			
Dimensions (W/D/H)	Weight	Kg	42	40
	Dimensions (W/D/H)	mm	280/450/750	280/450/750
G.C. Number			47-116-35	47-116-10

* Calculated at 70% maximum output

** Calculated on Upper calorific value

1.2. OVERALL VIEW

ACO 27/32 MFFI

ACO 27/32 RFFI SYSTEM

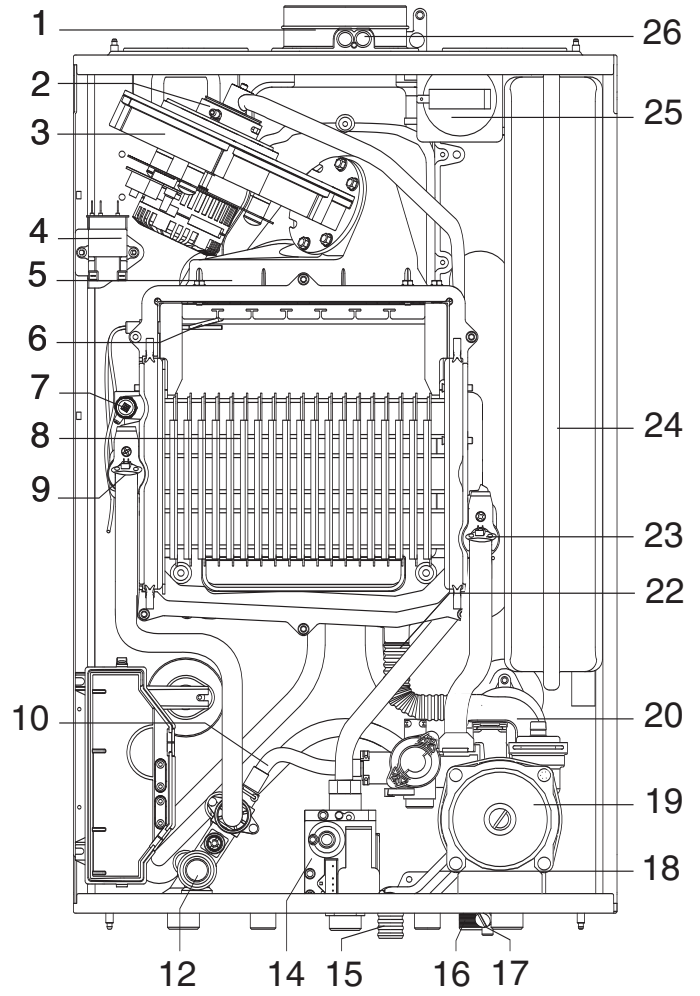
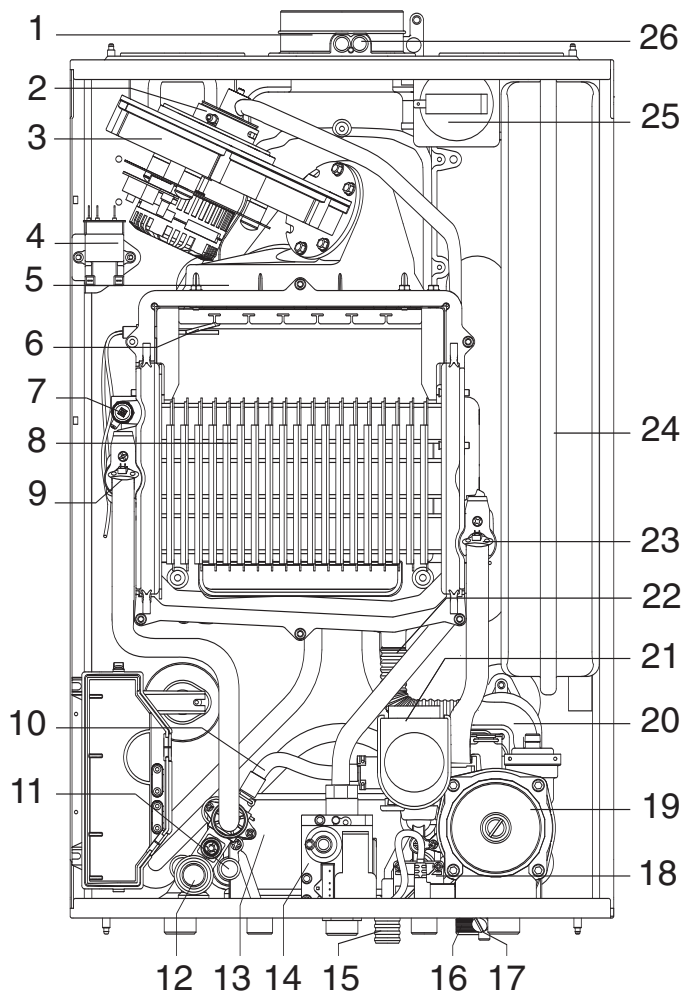

FIG. 1.0

LEGEND:

- 1. Flue connector
- 2. Mixer
- 3. Fan
- 4. Spark generator
- 5. Burner
- 6. Ignition and detection electrode
- 7. Air release valve
- 8. Main heat exchanger (aluminium)
- 9. Central Heating flow temperature probe
- 10. Automatic by-pass
- 11. Domestic Hot Water temperature probe
- 12. Safety valve (3 bar)
- 13. Secondary heat exchanger
- 14. Gas valve
- 15. Condensate discharge
- 16. Condensate trap inspection cap
- 17. Drain valve
- 18. Domestic Hot Water flow switch
- 19. Circulation pump with automatic air release valve
- 20. Condensate trap
- 21. Diverter valve
- 22. Condensate trap (tube)
- 23. Central Heating return temperature probe
- 24. Expansion vessel
- 25. Air pressure switch
- 26. Combustion analysis test point

2. INSTALLATION

2.1. REFERENCE STANDARDS

The technical information and instructions provided herein below are intended for the installer / Servicing Technician so that the unit may be installed and serviced correctly and safely.

In the United Kingdom the installation and initial start up of the boiler must be by a CORGI Registered Installer in accordance with the installation standards currently in effect, as well as with any and all local health and safety standards i.e. CORGI.

In the Republic of Ireland the installation and initial start up of the appliance must be carried out by a Competent Person in accordance with the current edition of I.S.813 "Domestic Gas Installations", the current Building Regulations, reference should also be made to the current ETCI rules for electrical installation.

This appliance must be installed by a competent installer in accordance with current Gas Safety (installation & use) Regulations.

The installation of this appliance must be in accordance with the relevant requirements of the Local Building Regulations, the current I.E.E. Wiring Regulations, the bylaws of the local water authority, in Scotland, in accordance with the Building Standards (Scotland) Regulation and Health and Safety document No. 635 "Electricity at work regulations 1989" and in the Republic of Ireland with the current edition of I.S. 813, the Local Building Regulations (IE).

C.O.S.H.H.

Materials used in the manufacture of this appliance are non-hazardous and no special precautions are required when servicing.

Installation should also comply with the following British Standard Codes of Practice:

BS 7593:1992	Treatment of water in domestic hot water central heating systems
BS 5546:1990	Installation of hot water supplies for domestic purposes
BS 5440-1:2000	Flues
BS 5440-2:2000	Air supply
BS 5449:1990	Forced circulation hot water systems
BS 6798:1987	Installation of gas fired hot water boilers of rated input not exceeding 60kW
BS 6891:1989	Installation of low pressure gas pipe up to 28mm
BS 7671:2001	IEE wiring regulations
BS 4814:1990	Specification for expansion vessels
BS 5482:1994	Installation of L.P.G.

and in the Republic of Ireland in accordance with the following Codes of Practice:

I.S. 813	Domestic Gas Installations
-----------------	-----------------------------------

The appliance may be installed in any room or indoor area, although particular attention is drawn to the requirements of the current I.E.E. Wiring Regulations, and in Scotland, the electrical provisions of the Building Regulations applicable in Scotland,

2.2. SITING THE APPLIANCE

The appliance may be installed in any room or indoor area, although particular attention is drawn to the requirements of the current I.E.E. Wiring Regulations, and in Scotland, the electrical provisions of the Building Regulations applicable in Scotland, with respect to the installation of the combined appliance in a room containing a bath or shower, the location of the boiler in a room containing a bath or shower should only be considered if there is no alternative.

Where a room-sealed appliance is installed in a room containing a bath or shower the appliance and any electrical switch or appliance control, utilising mains electricity should be situated so that it cannot be touched by a person using the bath or shower, specifically in accordance with current IEE Wiring Regulations.

The location must permit adequate space for servicing and air circulation around the appliance as indicated in Section 2.4. The location must permit the provision of an adequate flue and termination.

For unusual locations special procedures may be necessary. BS 6798-1987 gives detailed guidance on this aspect. A compartment used to enclose the appliance must be designed specifically for this purpose. No specific ventilation requirements are needed for the installation within a cupboard. This appliance is not suitable for outdoor installation.

The type C appliances (in which the combustion circuit, air vent intake and combustion chamber are air-tight with respect to the room in which the appliance is installed) can be installed in any type of room.

Secondary ventilation is not required with this boiler. The boiler must be installed on a solid, non-combustible, permanent wall to prevent access from the rear.

2.3. OVERALL DIMENSIONS

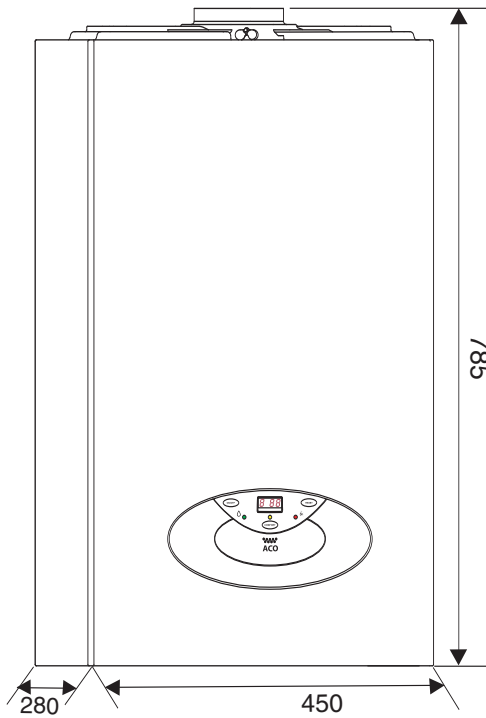

FIG. 2.0

LEGEND:

- A = Central Heating Flow (3/4")
- B = Domestic Hot Water Outlet (1/2")
- C = Gas Inlet (3/4")
- D = Domestic Cold Water Inlet (1/2")
- E = Central Heating Return (3/4")
- F = Condensate discharge

ACO 27/32 MFFI

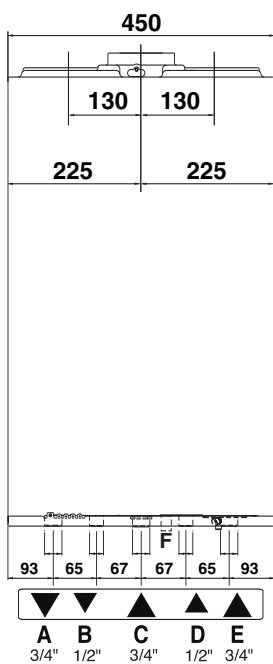

FIG. 2.1

ACO 27/32 RFFI SYSTEM

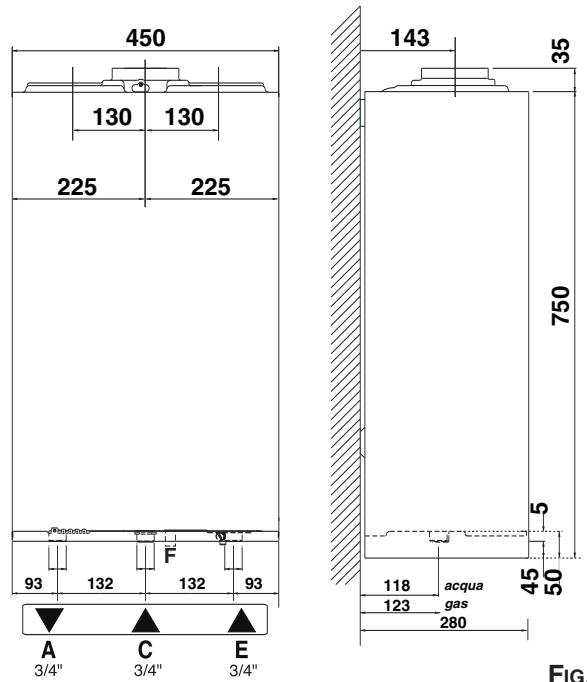

FIG. 2.1

2.4. MINIMUM CLEARANCES

In order to allow access to the interior of the boiler for maintenance purposes, the boiler must be installed in compliance with the clearance requirements indicated in the diagram below.

ACO 27/32 MFFI

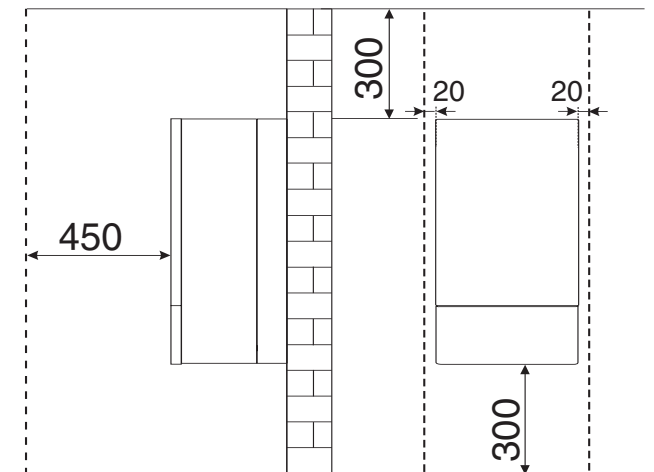

FIG. 2.2

ACO 27/32 RFFI SYSTEM

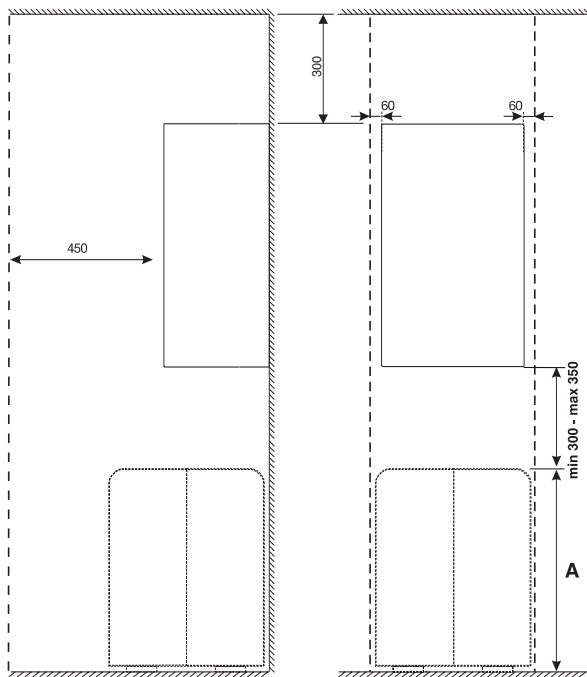

FIG. 2.2

2.5. MOUNTING THE APPLIANCE

Fasten the boiler in place using the template and anchors supplied with the unit. It is highly recommended that a spirit level be used to position the boiler so that it is perfectly level.

For additional information, please consult the instructions contained in the connection kit and the flue kit.

For safety purposes, have a competent person carefully check the electrical system in the property, as the manufacturer will not be held liable for damage caused by the failure to earth the appliance properly or by anomalies in the supply of power. Make sure that the residential electrical system is adequate for the maximum power absorbed by the unit, which is indicated on the rating plate. In addition, check that the section of cabling is appropriate for the power absorbed by the boiler.

2.6. ELECTRICAL CONNECTION

The boiler operates with alternating current, as indicated in the technical data table (Section 1.2), where the maximum absorbed power is also indicated. Make sure that the connections for the neutral and live wires correspond to the indications in the diagram. The appliance electrical connections are situated on the reverse of the control panel (see the Servicing Instructions for further information Section 6).

IMPORTANT!

In the event that the power supply cable must be changed, replace it with one with the same specifications. Make the connections to the terminal board located within the control panel, as follows:

- The yellow-green wire should be connected to the terminal marked with the earth symbol; make sure to re-use the ferrule mounted on the other supply cable;
- The blue wire should be connected to the terminal marked "N";
- The brown wire should be connected to the terminal marked "L".

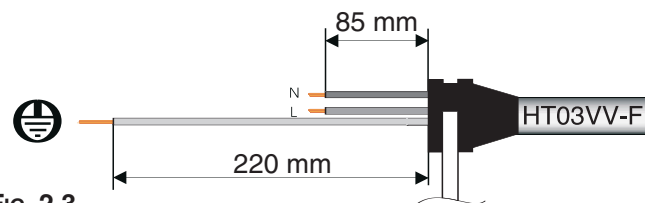

FIG. 2.3

Note: The diagrams for the electrical system are indicated in section 2.11.

Warning, this appliance must be earthed.

External wiring to the appliance must be carried out by a competent person and be in accordance with the current I.E.E. Regulations and applicable local regulations.

The appliance is supplied with a fly-lead already connected, this must be connected to a 240v supply fused at 3A and must facilitate complete electrical isolation of the appliance, by the use of a fused double pole isolator having a contact separation of at least 3 mm in all poles or alternatively, by means of a 3 A fused three pin plug and unswitched shuttered socket outlet both complying with BS 1363.

The point of connection to the Electricity supply must be readily accessible and adjacent to the appliance unless the appliance is installed in a bathroom when this must be sited outside the bathroom (see section 2.2).

Should external controls be required, the design of the external electrical circuits should be undertaken by a competent person, see Section 2.10 for further information.

2.7. GAS CONNECTION

The local gas region contractor connects the gas meter to the service pipe.

If the gas supply for the boiler serves other appliances ensure that an adequate supply is available both to the boiler and the other appliances when they are in use at the same time.

Pipe work must be of an adequate size. Pipes of a smaller size than the boiler inlet connection should not be used.

2.8. WATER CONNECTIONS

VIEW OF THE BOILER CONNECTIONS

ACO 27/32 MFFI

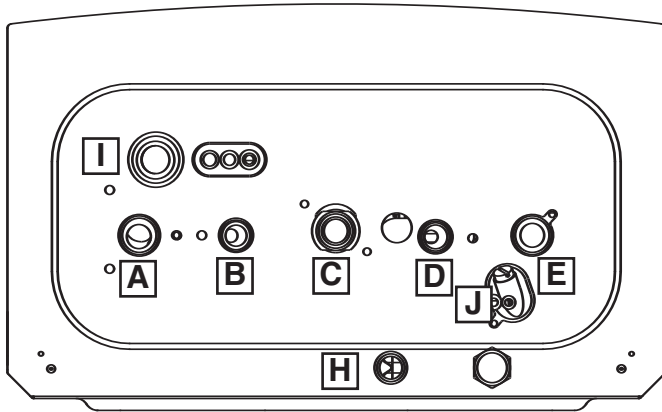

ACO 27/32 RFFI SYSTEM

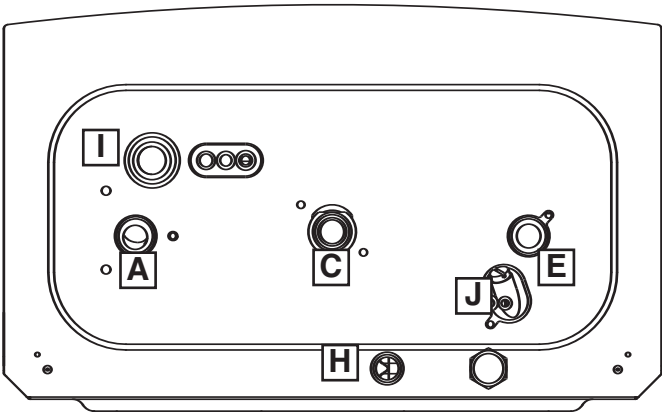

Fig. 2.4

Legend:

- A = Central Heating Flow**
- B = Domestic Hot Water Outlet**
- C = Gas Inlet**
- D = Domestic Cold Water Inlet**
- E = Central Heating Return**
- H = Condensate discharge**
- I = Safety valve discharge**
- J = Drain valve**

Central Heating

Detailed recommendations are given in BS 6798:1987 and BS 5449-1:1990, the following notes are given for general guidance.

PIPE WORK:

Copper tubing to BS EN 1057:1996 is recommended for water pipes. Jointing should be either with capillary soldered or compression fittings.

Where possible pipes should have a gradient to ensure air is carried naturally to air release points and water flows naturally to drain taps.

The appliance has a built-in automatic air release valve, however it should be ensured as far as possible that the appliance heat exchanger is not a natural collecting point for air.

Except where providing useful heat, pipes should be insulated to prevent heat loss and avoid freezing.

Particular attention should be paid to pipes passing through ventilated spaces in roofs and under floors.

BY-PASS:

The appliance includes an automatic by-pass valve, which protects the main heat exchanger in case of reduced or interrupted water circulation through the heating system, due to the closing of thermostatic valves or cock-type valves within the system.

SYSTEM DESIGN:

This boiler is suitable only for sealed systems.

DRAIN COCKS:

These must be located in accessible positions to permit the draining of the whole system. The taps must be at least 15mm nominal size and manufactured in accordance with BS 2870:1980.

SAFETY VALVE DISCHARGE:

The discharge should terminate facing downwards on the exterior of the building in a position where discharging (possibly boiling water & steam) will not create danger or nuisance, but in an easily visible position, and not cause damage to electrical components and wiring.

The discharge must not be over an entrance or a window or any other type of public access.

CONDENSATE DISCHARGE:

The condensate discharge hose from the boiler must have a continuous fall of 2.5° and must be inserted by at least 50 mm into a suitable acid resistant pipe - e.g. plastic waste or overflow pipe. The condensate discharge pipe must have a continuous fall and preferably be installed and terminated within the building to prevent freezing.

The discharge pipe must be terminated in a suitable position:

- i) Connecting in to an internal soil stack (at least 450 mm above the invert of the stack). A trap giving a water seal of at least 75 mm must be incorporated into the pipe run, there also must be an air break upstream of the trap.

- ii) Connecting into the waste system of the building such as a washing machine or sink trap. The connection must be upstream of the washing machine/sink (If the connection is down stream of the waste trap then an additional trap giving a minimum water seal of 75 mm and an air break must be incorporated in the pipe run, as above.
- iii) Terminating into a gully, below the grid level but above the water level.
- iv) Into a soakway.

NOTE: If any condensate pipe work is to be installed externally, then it should be kept to a minimum and be insulated with a waterproof insulation and have a continuous fall.

AIR RELEASE POINTS:

These must be fitted at all high points where air naturally collects and must be sited to facilitate complete filling of the system.

The appliance has an integral sealed expansion vessel to accommodate the increase of water value when the system is heated.

It can accept up to 7 l (1.5 gal) of expansion water. If the heating circuit has an unusually high water content, calculate the total expansion and add an additional sealed expansion vessel with adequate capacity.

MAINS WATER FEED - CENTRAL HEATING:

There must be no direct connection to the mains water supply even through a non-return valve, without the approval of the Local Water Authority.

FILLING:

A method for initially filling the heating system is supplied with the connection kit. The filling loop is connected between the cold water inlet and the central heating flow connections, and incorporates a non-return valve. To operate the filling loop, it is necessary to open both quarter turn handles, once the required pressure has been achieved, close both handles and disconnect the hose in accordance with water byelaws. NOTE: The installer should ensure that there are no leaks as frequent filling of the heating system can lead to premature scaling of the main exchanger and failure of hydraulic components.

DOMESTIC WATER

The domestic water must be in accordance with the relevant recommendation of BS 5546:1990. Copper tubing to BS EN 1057:1996 is recommended for water carrying pipe work and must be used for pipe work carrying drinking water, a scale reducer should also be used to reduce the risk of scale forming in the domestic side of the heat exchanger.

UNDER FLOOR HEATING SYSTEMS:

In the event of an under floor heating system, fit a safety thermostat on the boiler flow (see Section 2.10). This thermostat should be positioned at a safe distance from the boiler to ensure the correct operation of the same. If the thermostat is positioned too close to the boiler, the water remaining in the boiler after domestic hot water has been drawn will flow into the central heating system and may cause the thermostat contact to open without there being any real danger of the system being damaged, this would lead to a boiler shutdown both in D.H.W. mode and C.H. mode, and the error code "E08" would be displayed; boiler operation resumes automatically when the thermostat contact closes on cooling. Should the thermostat fail to be installed as recommended, the under floor heating system can be protected by installing a thermostatic valve upstream from the thermostat in order to prevent the flow of excessively hot water towards the system.

ACO 27/32 MFFI



ACO 27/32 RFFI SYSTEM



RESIDUAL HEAD OF THE BOILER

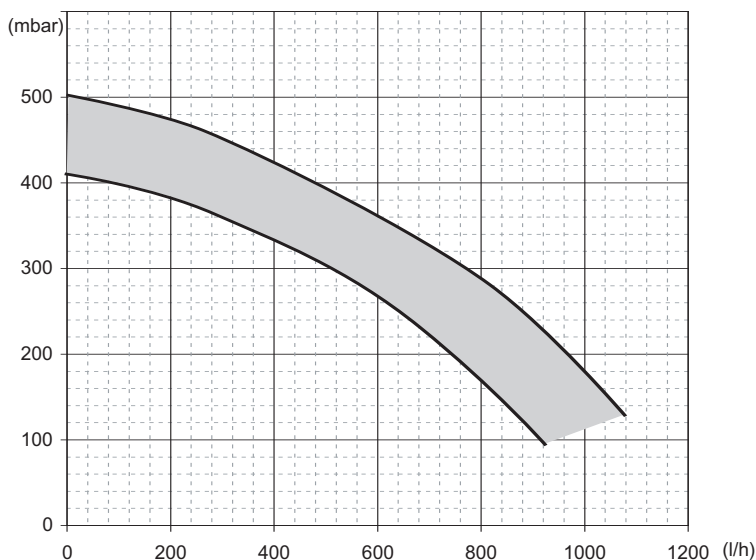

FIG. 2.5

WATER TREATMENT

The boiler is equipped with an aluminium alloy main heat exchanger.

The detailed recommendations for water treatment are given in BS 7593:1992 (Treatment of water in domestic hot water central heating systems); the following notes are given for general guidance:

- If the boiler is installed in an existing system, any unsuitable additives must be removed;
- Under no circumstances should the boiler be fired before the system has been thoroughly flushed; the flushing procedure must be in line with BS7593:1992.

We highly recommend the use of a flushing detergent appropriate for the metals used in the aluminium alloy circuit. These include (Fernox Superfloc, BetzDearborn Sentinel X300 or X400 or Salamander System Cleanser), whose function is to dissolve any foreign matter that may be in the system;

In hard water areas or where large quantities of water are in the system the treatment of the water to prevent premature scaling of the main heat exchanger is necessary.

The formation of scale strongly compromises the efficiency of the thermic exchange because small areas of scale cause a high increase of the temperature of the metallic walls and therefore add to the thermal stress of the heat exchanger.

Demineralized water is more aggressive so in this situation it is necessary to treat the water with an appropriate corrosion inhibitor.

- Any treatment of water by additives in the system for frost protection or for corrosion inhibition has to be absolutely suitable for all the metals used in the circuit including the aluminium alloys.

The use of a corrosion inhibitor in the system such as Fernox MB-1, BetzDearborn Sentinel X100 or Copal Salamander System Inhibitor is recommended to prevent corrosion (sludge) damaging the boiler and systems;

- If anti-freeze substances are to be used in the system, check carefully that they are compatible with the aluminium.

In particular, **DO NOT USE** ordinary ETHYLENE GLYCOL, since it is corrosive in relation to aluminium and its alloy, as well being toxic.

MTS suggests the use of suitable anti-freeze products such as Fernox ALPHI 11, which will prevent rust and incrustation taking place.

Periodically check the pH of the water/anti-freeze mixture of the boiler circuit and replace it when the amount measured is out of the range stipulated by the manufacturer ($7 < \text{pH} < 8$).

DO NOT MIX DIFFERENT TYPES OF ANTI-FREEZE

- In under-floor systems, the use of plastic pipes without protection against penetration of oxygen through the walls can cause corrosion of the system's metal parts (metal piping, boiler, etc), through the formation of oxides and bacterial agents.

To prevent this problem, it is necessary to use pipes with an "oxygen-proof barrier", in accordance with standards DIN 4726/4729. **If pipes of this kind are not used, keep the system separate by installing heat exchangers of those with a specific system water treatment.**

IMPORTANT

Failure to carry out the water treatment procedure may invalidate the appliance warranty

2.9. FLUE CONNECTIONS

IMPORTANT!!

BEFORE CONNECTING THE FLUE, ENSURE THAT 1 LITRE OF WATER HAS BEEN POURED INTO THE EXHAUST CONNECTION TO FILL THE CONDENSATE TRAP (FIG.2.6). SHOULD THE TRAP BE EMPTY THERE IS A RISK OF FLUE GASSES ESCAPING INTO THE ROOM.

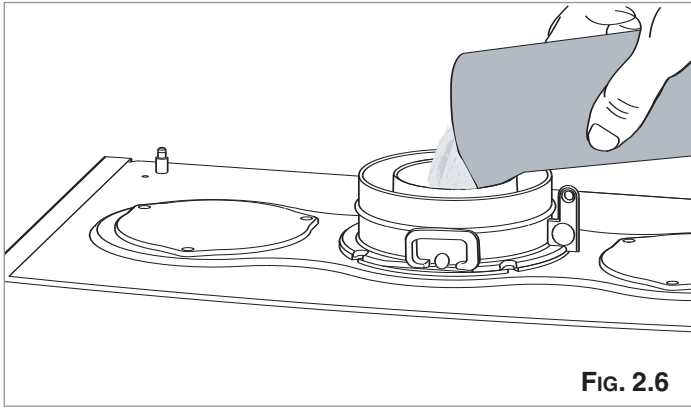
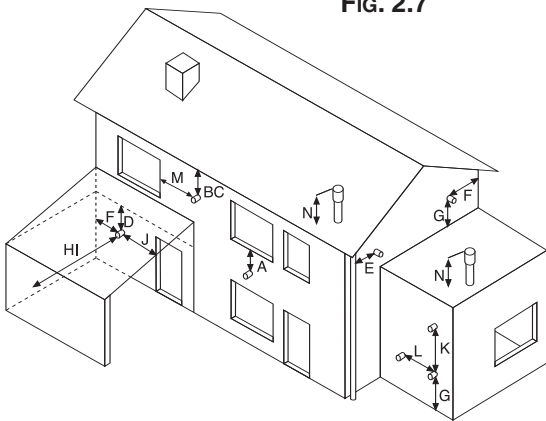

FIG. 2.6

FIG. 2.7



FLUE SYSTEM

The provision for satisfactory flue termination must be made as described in BS 5440-1.

The appliance must be installed so that the flue terminal is exposed to outdoor air.

The terminal must not discharge into another room or space such as an outhouse or lean-to.

It is important that the position of the terminal allows a free passage of air across it at all times.

The terminal should be located with due regard for the damage or discolouration that might occur on buildings in the vicinity.

In cold or humid weather water vapour may condense on leaving the flue terminal.

The effect of such "steaming" must be considered.

If the terminal is less than 2 metres above a balcony, above ground or above a flat roof to which people have access, then a suitable terminal guard must be fitted. When ordering a terminal guard, quote the appliance model number.

A suitable terminal guard is available from:

TOWER FLUE COMPONENTS

**Morley Road
Tonbridge
Kent TN9 1RA**

The minimum acceptable spacing from the terminal to obstructions and ventilation openings are specified in Fig. 2.7.

TERMINAL POSITION

mm

A - Directly below an open window or other opening	300
B - Below gutters, solid pipes or drain pipes	75
C - Below eaves	200
D - Below balconies or car-port roof	200
E - From vertical drain pipes and soil pipes	75
F - From internal or external corners	300
G - Above ground or below balcony level	300
H - From a surface facing a terminal	600
I - From a terminal facing a terminal	1200
J - From an opening in the car port (e.g. door, window) into dwelling	1200
K - Vertically from a terminal in the same wall	1500
L - Horizontally from a terminal in the same wall	300
M - Horizontally from an opening window	300
N - Fixed by vertical flue terminal	

27 MFFI	Exhaust Type	Maximum Extension Exhaust/Air (m)	Diameter of Pipes (mm)
Coaxial Systems	C ₁₃	4	Ø 60/100
	C ₁₃ , C ₃₃ , C ₄₃	20 (S1=S2)	Ø 80/80
Twin Pipe Systems	C ₅₃ , C ₈₃	1+39 (S1+S2)	Ø 80/80

32 MFFI	Exhaust Type	Maximum Extension Exhaust/Air (m)	Diameter of Pipes (mm)
Coaxial Systems	C ₁₃	4	Ø 60/100
Twin Pipe Systems	C ₁₃ , C ₃₃ , C ₄₃	24 (S1=S2)	Ø 80/80
	C ₅₃ , C ₈₃	1+48 (S1+S2)	Ø 80/80

In FIG. 2.8 (PAGE 11), several different types of flue systems are shown.

For additional information regarding the flue accessories, please consult the Flue Pipe Accessories manual.

FIG. 2.8

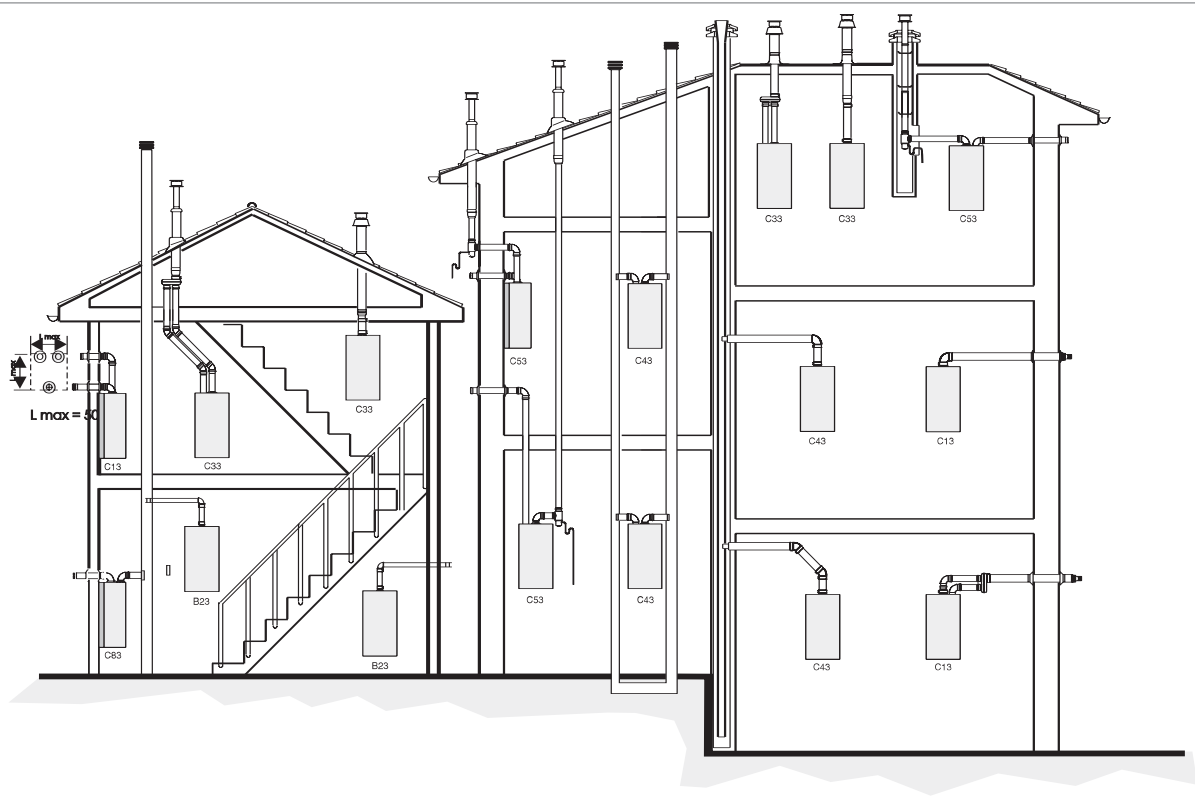

2.10. ACCESSORY CONNECTION

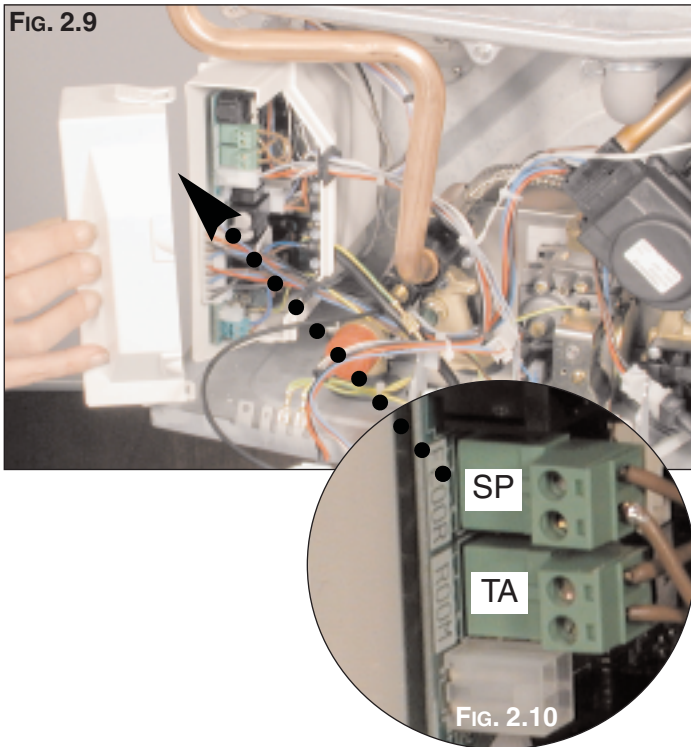

IMPORTANT!!

Before carrying out any repairs to the appliance always ensure that the external power supply has been isolated. The boiler will remain live even when the ON/OFF knob is in the "O"(off) position.

In order to gain access to the external control connections, it is first necessary to remove the casing (as shown in Section 3.2) then proceed as follows:

1. Remove the cover of the main PCB box (Fig 2.9).
2. Access can now be gained to the following connector (see Section 2.11):
 - CN10 - Safety thermostat for underfloor heating
 - CN 9 - Room Thermostat
 - CN 11 - Time clock
 - CN 6 - Interface PCB

CONNECTION OF ROOM THERMOSTAT OR EXTERNAL TIME CLOCK

- a. - Insert the thermostat cable through the cable grommet and fasten it by means of the cable-clamp provided.
- b. - Connect the thermostat wires to the terminal block CN9 (Fig. 2.12 - Diagram A).
- c. - If a remote time clock is to be fitted, disconnect the integral time clock from the P.C.B. CN11
- d. - Using a volt-free switching time clock, connect the switching wires from the time clock following points 1-4 above (Fig. 2.12 - Diagram B).
- e. - If using an external time clock and room thermostat, these must be connected in series as points 1-7 above (Fig. 2.12 - Diagram C).

IMPORTANT!!

Only remove the links from SP and TA if they are to be connected to external controls.

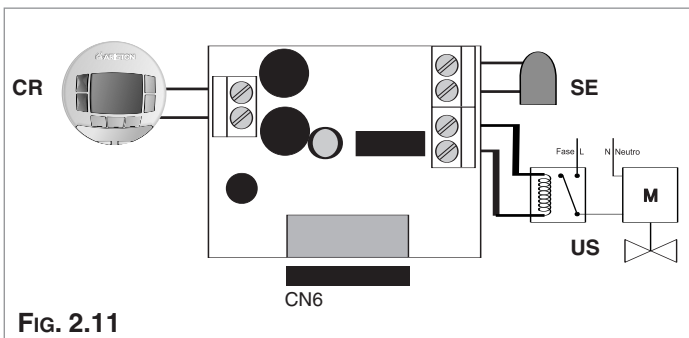

CONNECTION OF INTERFACE PCB (optional)

The Interface PCB allows for the connection of:
 REMOTE CONTROL - Clima Manager
 External sensor
 Secondary outlet (*)

(*) = The secondary outlet can be used for the connection of the following accessories:

- Zone valve
- LPG valve
- Secondary Pump

When connecting one of the above accessories it is necessary to modify the **E** parameter on the Parameter Menu (see Section 3.6.1)

FIG. 2.11

Diagram A
Room Thermostat

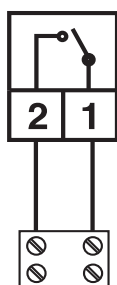

Boiler terminal block
(located on reverse
of the control panel)

Timedclock and Room Thermostat
low voltage compatible

Diagram B
External Timeclock /
Programmer

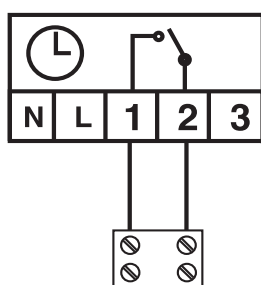

Boiler terminal block
(located on reverse
of the control panel)

Diagram C
External Room Thermostat and Volt
Free Timeclock / Programmer Wired
in Series

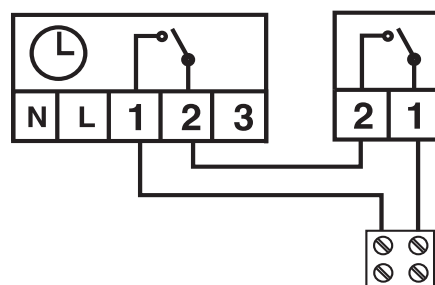

Boiler terminal block
(located on reverse
of the control panel)

FIG. 2.12

2.11. ELECTRICAL DIAGRAM

The P.C.B. is fitted with 2 fuses, on the live and the neutral.

The fuse holder contains:

- 5 x 20mm "3.15A Slow" glass fuses

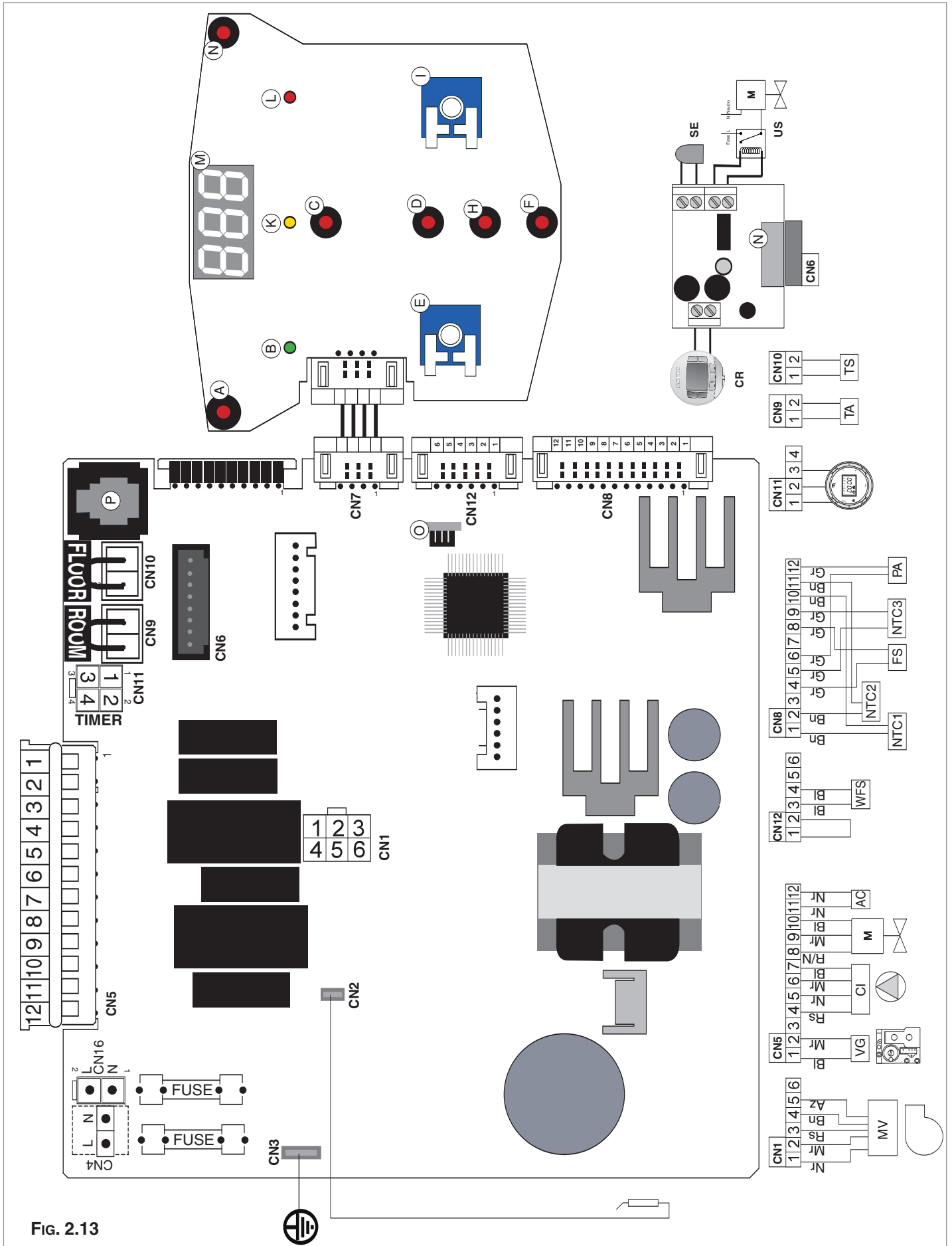

FIG. 2.13

Legend:

- A** - ON/OFF button
 - B** - Multifunction display
 - C** - RESET button
 - D** - Green led (indicates burner on)
 - E** - Comfort function yellow LED
 - F** - Red LED (indicates lockout)
 - G** - COMFORT button
 - H** - Programming key +
 - I** - Programming key -
 - J** - Menu button
 - K** - Central Heating temperature adjustment
 - L** - Domestic Hot Water temperature adjustment
 - M** - Eepron
 - N** - Interface PCB (optional)
-
- FS** - Domestic hot water flow switch
 - NTC1** - Central Heating flow temperature probe
 - NTC2** - Central Heating return temperature probe
 - NTC3** - Domestic Hot Water temperature probe (mod. 27/32 MFFI)
 - Connection for boiler thermostat (mod. 27/32 RFFI SYSTEM)
 - OP** - Time clock
 - VG** - Gas valve
 - M** - Diverter valve (mod. 27/32 MFFI)
 - Connection for external diverter valve (mod. 27/32 RFFI SYSTEM)
 - CI** - Circulation pump with automatic air release valve
 - MV** - Fan
 - AC** - Spark generator
 - PA** - Air pressure switch
 - TA** - Room Thermostat (optional)
 - TS** - Underfloor Heating Safety Thermostat (optional)
 - CR** - Remote Control (optional)
 - SE** - External sensor (optional)
 - US** - Secondary outlet (optional)

CN1 = FAN

- 1: Start of coil (black)
- 2: End of coil (brown)
- 3: "Hall" sensor power supply 12V (red)
- 4: "Hall" sensor input (white)
- 5: "Hall" sensor neutral (blue)
- 6: Not used

CN2 = FLAME SENSOR

CN3 = Earth

CN4 = POWER SUPPLY

- 1: Live (brown)
- 2: Neutral (blue)

CN5 = EQUIPMENT CONNECTIONS

- 1: Gas valve neutral (blue)
- 2: Gas valve live (brown)
- 3: Not used
- 4: Pump (V1) live (red)
- 5: Pump (V2) live (black)
- 6: Pump (ON/OFF) live (brown)
- 7: Pump neutral (blue)
- 8: 3-way valve (D. H. W.) (brown)
- 9: 3-way valve (C. H.) (red/black)
- 10: 3-way valve Neutral (blue)
- 11: Spark generator Neutral (blue)
- 12: Spark generator live (black)

CN6 = INTERFACE PCB (OPTIONAL - see paragraph 2.10)

- Accessories:
External sensor
Remote Control CLIMA MANAGER
Secondary outlet (see Section. 2.10)

CN7 = DISPLAY

- 1: Power 5V
- 2: Display return
- 3: Display transmission
- 4: Earth

CN8 = SENSOR CONNECTOR

- 1: Central Heating flow sensor (white)
- 2: Central Heating return sensor (white)
- 3: Not used
- 4: DHW flow switch (grey)
- 5: DHW sensor (grey)
- 6: Not used
- 7: Not used
- 8: DHW flow switch earth (grey)
- 9: DHW sensor earth (grey)
- 10: C.H. flow sensor earth (white)
- 11: C.H. return sensor earth (white)
- 12: Not used

CN9 = ROOM THERMOSTAT (OPTIONAL - see paragraph 2.10)

CN10 = UNDERFLOOR HEATING SAFETY THERMOSTAT (OPTIONAL - see paragraph 2.10)

CN11 = TIME CLOCK see paragraph 2.10

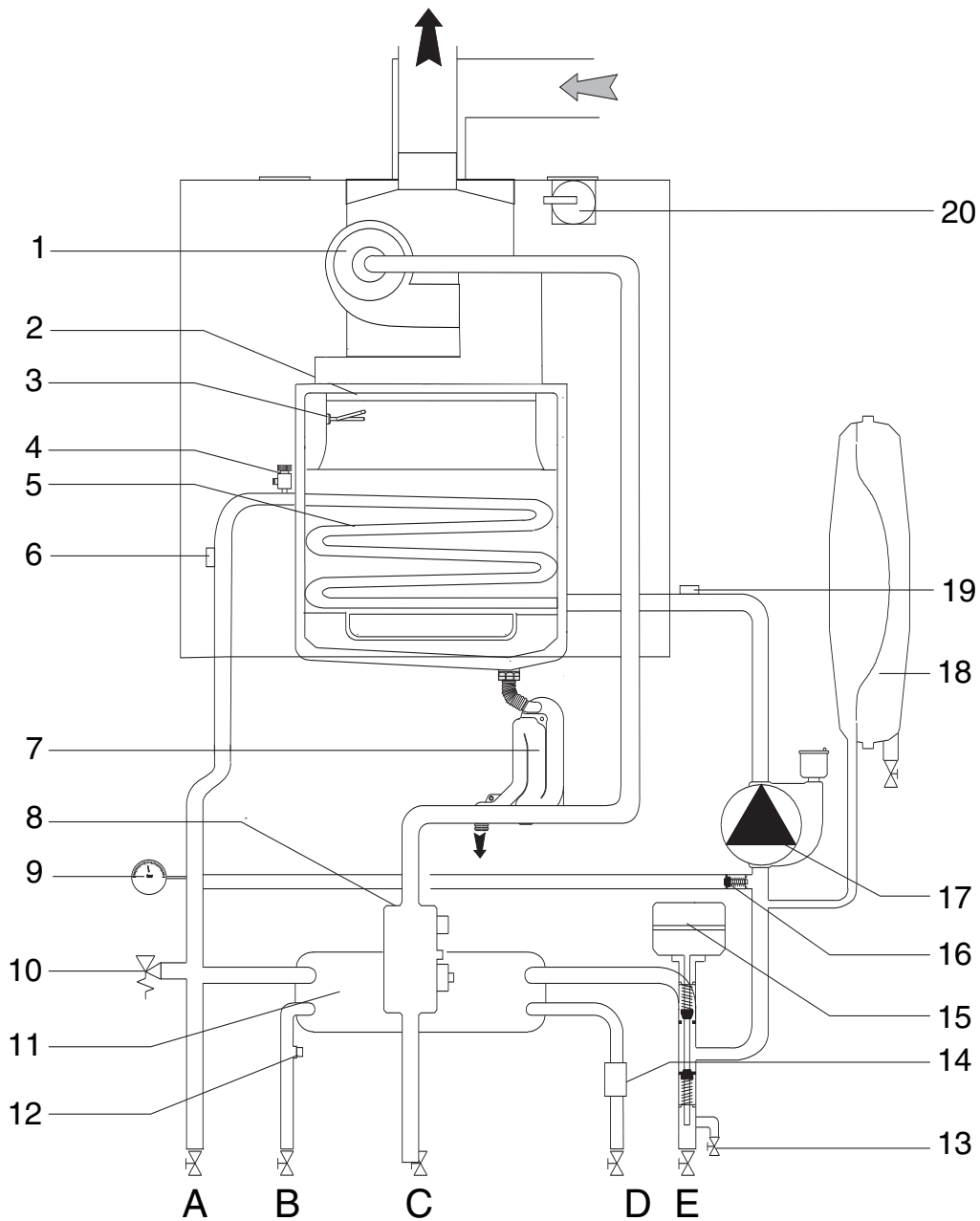

FIG. 2.14

LEGEND:

- | | |
|--|--|
| 1 - Fan | 14 - Domestic hot water flow switch |
| 2 - Burner | 15 - Motorised valve |
| 3 - Ignition/detection electrode | 16 - Automatic By-pass |
| 4 - Air release valve | 17 - Circulation pump with automatic air release valve |
| 5 - Main heat exchanger | 18 - Expansion vessel |
| 6 - Central heating flow temperature probe | 19 - Central heating return temperature probe |
| 7 - Condensate Trap | 20 - Air pressure switch |
| 8 - Gas valve | |
| 9 - Pressure gauge | |
| 10 - Safety valve | |
| 11 - Secondary heat exchanger | |
| 12 - Domestic hot water temperature probe | |
| 13 - Drain valve | |

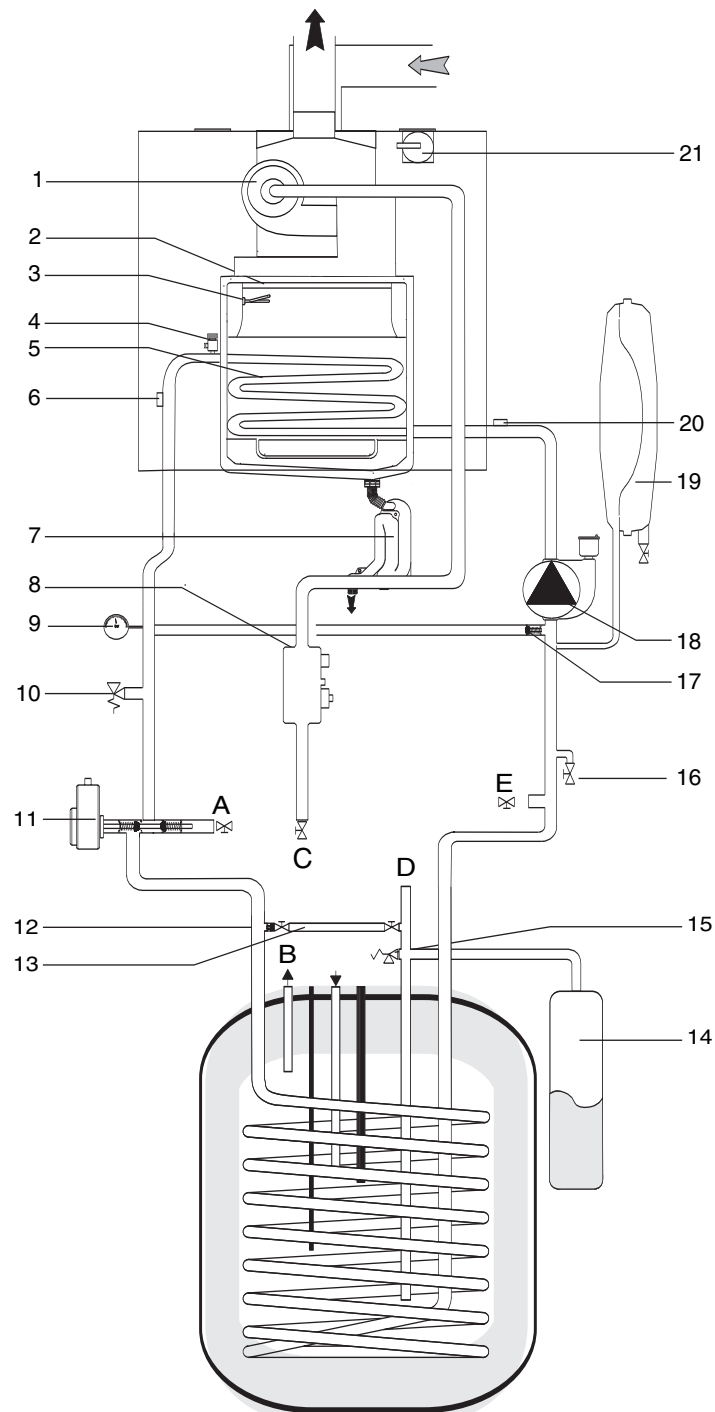

FIG. 2.14

LEGEND:

- | | |
|---|--|
| 1 - Fan | 15 - Expansion relief valve |
| 2 - Burner | 16 - Drain valve |
| 3 - Ignition/detection electrode | 17 - Automatic By-pass |
| 4 - Air release valve | 18 - Circulation pump with automatic air release valve |
| 5 - Main heat exchanger | 19 - Expansion vessel |
| 6 - Central heating flow temperature probe | 20 - Central heating return temperature probe |
| 7 - Condensate Trap | 21 - Air pressure switch |
| 8 - Gas valve | |
| 9 - Pressure gauge | |
| 10 - Safety valve | |
| 11 - D.H.W. priority valve (Optional extra) | |
| 12 - Non-return valve (integral to Jig Kit) | |
| 13 - Filling loop (integral to Jig Kit) | |
| 14 - Indirect cylinder expansion vessel | |

3. COMMISSIONING

3.1. INITIAL PREPARATION

MTS (GB) Limited support the *benchmark* initiative. Within the information pack you will find a copy of the *benchmark* Log Book. It is important that this is completed in the presence of your customer, they are shown how to use it, and it is signed by them. Please instruct your customer that they must have their *benchmark* Log Book with them whenever they contact a service engineer or us.

Preliminary electrical system checks to ensure electrical safety must be carried out by a competent person i.e. polarity, earth continuity, resistance to earth and short circuit.

FILLING THE HEATING SYSTEM:

Remove the panels of the case and lower the control panel (see section 3.2. for further information).

Open the central heating flow and return cocks supplied with the connection kit.

Unscrew the cap on the automatic air release valve one full turn and leave open permanently.

Close all air release valves on the central heating system.

Gradually open valve(s) at the filling point (filling-loop) connection to the central heating system until water is heard to flow, do not open fully.

Open each air release tap starting with the lowest point and close it only when clear water, free of air, is visible.

Purge the air from the pump by unscrewing the pump plug and also manually rotate the pump shaft in the direction indicated by the pump label to ensure the pump is free.

Close the pump plug.

Continue filling the system until at least 1 bar registers on the pressure gauge.

Inspect the system for water soundness and remedy any leaks discovered.

FILLING OF THE D.H.W. SYSTEM:

Close all hot water draw-off taps.

Open the cold water inlet cock supplied with the connection kit.

Open slowly each draw-off tap and close it only when clear water, free of bubbles, is visible

GAS SUPPLY:

Inspect the entire installation including the gas meter, test for soundness and purge, all as described in BS 6891:1988.

Open the gas cock (supplied with the connection kit) to the appliance and check the gas connector on the appliance for leaks.

Water Treatment

The boiler is equipped with an aluminium alloy main heat exchanger.

The detailed recommendations for water treatment are given in BS 7593:1992 (Treatment of water in domestic hot water central heating systems); the following notes are given for general guidance:

- If the boiler is installed in an existing system, any unsuitable additives must be removed;
- Under no circumstances should the boiler be fired before the system has been thoroughly flushed; the flushing procedure must be in line with BS7593:1992.

We highly recommend the use of a flushing detergent appropriate for the metals used in the aluminium alloy circuit. These include (Fernox Superfloc, BetzDearborn Sentinel X300 or X400 or Salamander System Cleanser), whose function is to dissolve any foreign matter that may be in the system;

In hard water areas or where large quantities of water are in

the system the treatment of the water to prevent premature scaling of the main heat exchanger is necessary.

The formation of scale strongly compromises the efficiency of the thermic exchange because small areas of scale cause a high increase of the temperature of the metallic walls and therefore add to the thermal stress of the heat exchanger. Demineralized water is more aggressive so in this situation it is necessary to treat the water with an appropriate corrosion inhibitor.

- Any treatment of water by additives in the system for frost protection or for corrosion inhibition has to be absolutely suitable for all the metals used in the circuit including the aluminium alloys.

The use of a corrosion inhibitor in the system such as Fernox MB-1, BetzDeaborn Sentinel X100 or Copal Salamander System Inhibitor is recommended to prevent corrosion (sludge) damaging the boiler and systems;

- If anti-freeze substances are to be used in the system, check carefully that they are compatible with the aluminium.

In particular, **DO NOT USE** ordinary ETHYLENE GLYCOL, since it is corrosive in relation to aluminium and its alloy, as well being toxic.

MTS suggests the use of suitable anti-freeze products such as Fernox ALPHI 11, which will prevent rust and incrustation taking place.

Periodically check the pH of the water/anti-freeze mixture of the boiler circuit and replace it when the amount measured is out of the range stipulated by the manufacturer ($7 < \text{pH} < 8$).

DO NOT MIX DIFFERENT TYPES OF ANTI-FREEZE

- In under-floor systems, the use of plastic pipes without protection against penetration of oxygen through the walls can cause corrosion of the system's metal parts (metal piping, boiler, etc), through the formation of oxides and bacterial agents.

To prevent this problem, it is necessary to use pipes with an "oxygen-proof barrier", in accordance with standards DIN 4726/4729. **If pipes of this kind are not used, keep the system separate by installing heat exchangers of those with a specific system water treatment.**

IMPORTANT

Failure to carry out the water treatment procedure may invalidate the appliance warranty

When the installation and filling are completed turn on the central heating system (Section 3.4) and run it until the temperature has reached the boiler operating temperature.

The system must then be immediately flushed through.

The flushing procedure must be in line with BS 7593:1992 Code of practice for treatment of water in domestic hot water central heating systems.

During this operation, we highly recommend the use of a central heating flushing detergent (Fernox Superfloc or equivalent), whose function is to dissolve any foreign matter that may be in the system.

Substances different from these could create serious problems to the pump or other components.

The use of an inhibitor in the system such as Fernox MB-1 or equivalent is strongly recommended to prevent corrosion (sludge) damaging the boiler and system.

Failure to carry out this procedure may invalidate the appliance warranty.

3.2. REMOVING THE CASING

To remove the front casing panel, follow these steps:

1. Remove the screws "A" (Fig 3.1);
2. Remove the four screws from case hooks (two at the top and two at the bottom) and rotate anti-clockwise (Fig 3.2);
3. Lift and unhook the case panel (Fig 3.3).

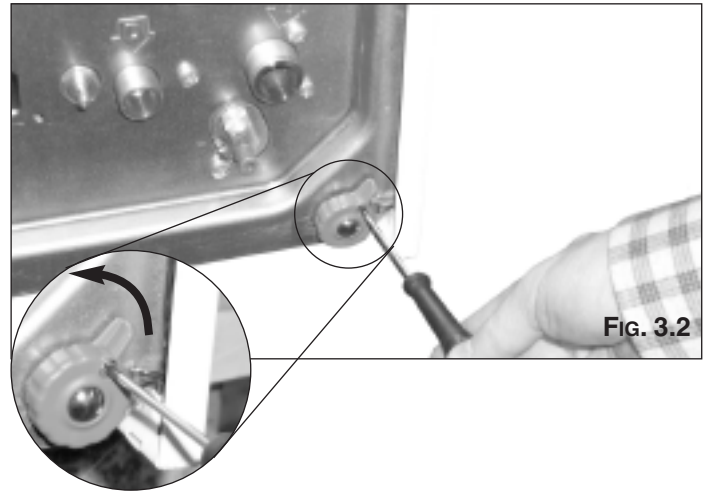

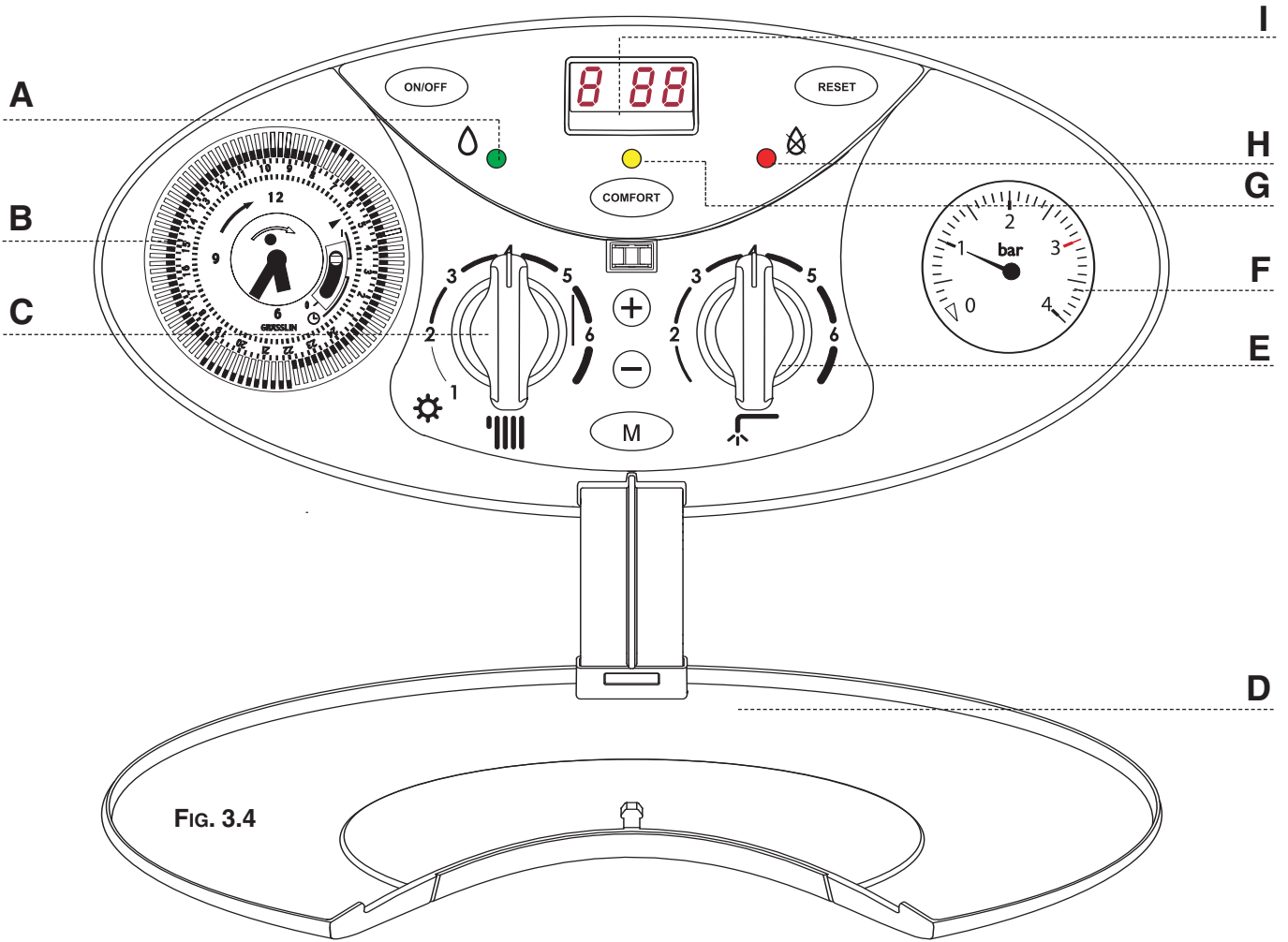

FIG. 3.4

Button	Description
ON/OFF	ON/OFF Switch
COMFORT	“COMFORT” Function Push-button
RESET	Reset Button/ Flue Test**/ scroll through Functions Menu
M	Menu Switch
+	Programming “+” key
-	Programming “-” key

**** IMPORTANT!!**
The Flue Test function will cause the boiler to run continuously on maximum power. This function must only be activated by an authorised engineer.

	Description
A	Green LED (illuminated = burner on)
B	Time clock
C	Selector knob for Summer/Winter Central Heating Temperature Adjustment Knob
D	Control Panel Cover
E	Domestic Hot Water Temperature Adjustment Knob
F	Heating System Pressure Gauge
G	“COMFORT” Function L.E.D
H	Red LED (illuminated = boiler lockout)
I	Multi-function Display

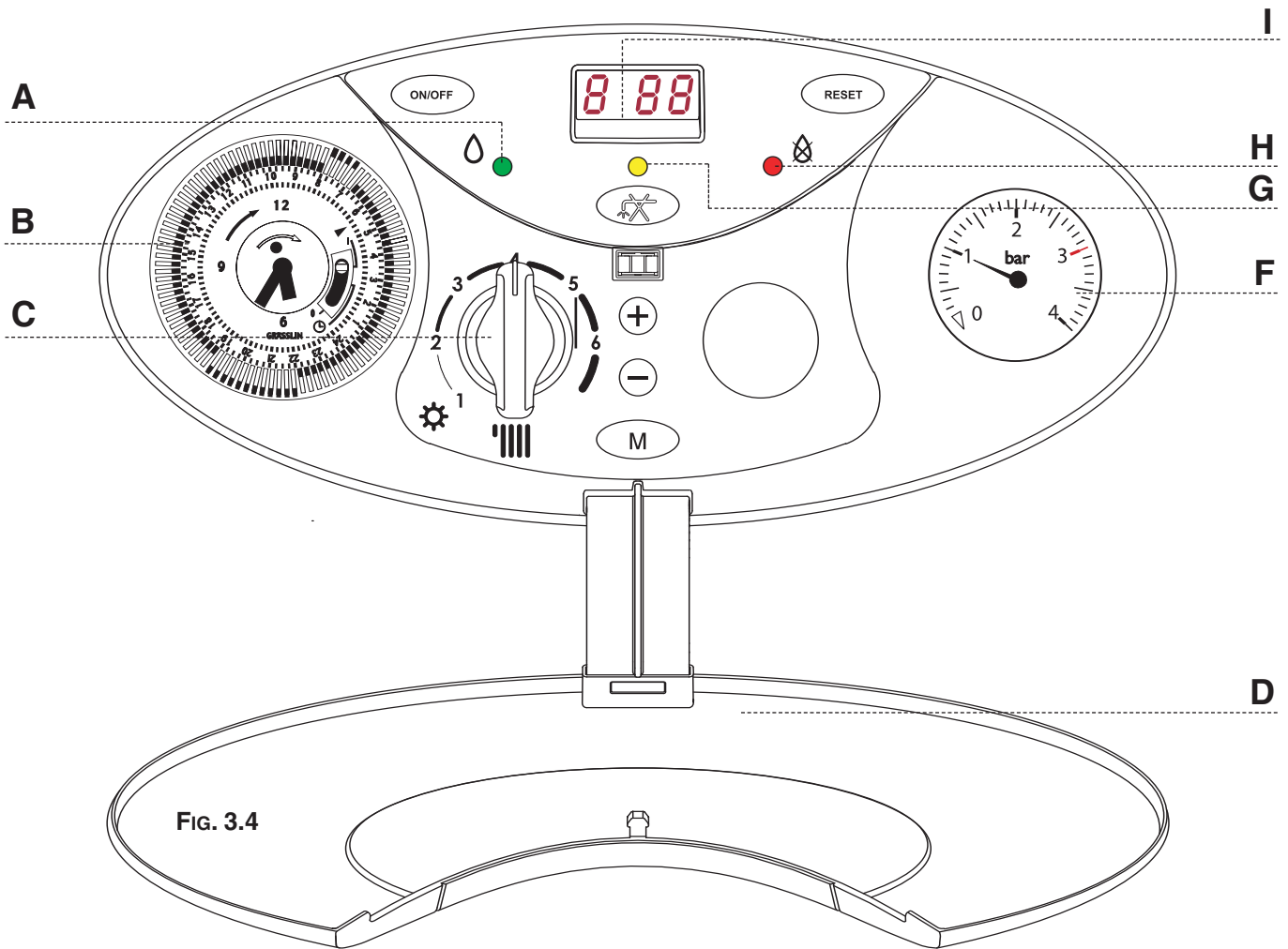

FIG. 3.4

Button	Description		Description
	ON/OFF Switch	A	Green LED (illuminated = burner on)
	Heating only	B	Time clock
	Reset Button/ Flue Test**/ scroll through Functions Menu	C	Selector knob for Summer/Winter Central Heating Temperature Adjustment Knob
	Menu Switch	D	Control Panel Cover
	Programming "+" key	F	Heating System Pressure Gauge
	Programming "-" key	G	Heating only L.E.D
		H	Red LED (illuminated = boiler lockout)
		I	Multi-function Display

**** IMPORTANT!!**
The Flue Test function will cause the boiler to run continuously on maximum power. This function must only be activated by an authorised engineer.

3.4. INITIAL START-UP

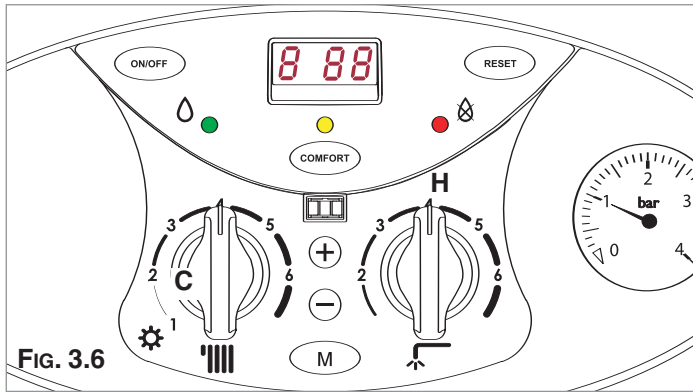

FIG. 3.6

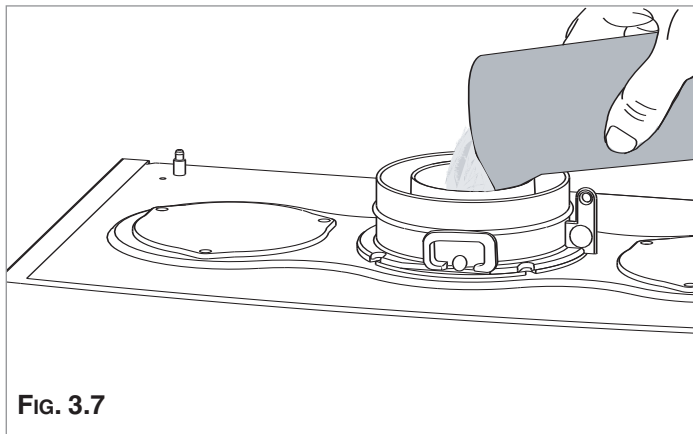

FIG. 3.7

1. Make sure that:
 - the cap of the automatic air release valve is loosened;
 - the system pressure is at least 1 bar on the pressure gauge "F" (Fig. 3.4);
 - the gas cock is closed (Fig. 3.5);
 - the electrical connection has been carried out in the correct manner.

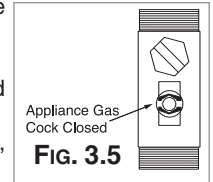

FIG. 3.5

To allow the air to escape from the system, proceed as follows:

- push the On/off button **ON/OFF** and turn the knob "C" (Fig. 3.6) to the "winter" position. The boiler pump will start up and three consecutive attempts will be made to ignite the burner. After the third attempt, the electronic system will shutdown the boiler, because the supply of gas has been cut off. The message "R0?" will appear on the display and the red LED "H" will illuminate;
- let the pump operate until all the air has escaped from the system;
- repeat the procedure for bleeding the radiators of air;
- draw hot water for a short while;
- check the system pressure and, if it has gone down, fill it with water until it returns to 1 bar.

2. Fill the boiler condensate trap with water, by pouring 1/2 a litre of water into the exhaust flue connector (see fig. 3.7). **N.B. In the event of a prolonged period of system shutdown, the condensate trap should be filled before any renewed use. A shortage of water in the trap is dangerous because it could possibly lead to a leakage of fumes into the air.**

3. Ensure that the flue is filled correctly.

4. Turn on the gas cock (fig. 3.8) and check the seals on the connections, including the one for the burner, making sure that the meter does not signal the passage of gas. Check the connections with a soap solution and eliminate any leaks.

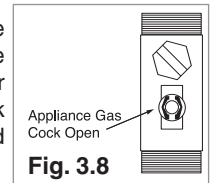

FIG. 3.8

5. Press the reset button **RESET**, the boiler will attempt to light. If the burner does not light the first time, repeat the procedure. Note: Should the boiler fail to ignite check that no air is present in the gas pipe.

The boiler is configured in the factory for the gas type in question. To check the air/gas ratio, please refer to section 3.6.4.

6. Complete the Benchmark log book.

3.5. DISPLAY: MESSAGES SHOWN DURING NORMAL OPERATION

During operation of the boiler, while it is carrying out its normal operations, the left-hand display shows a series of characters that refer to the operations indicated below:

- Diagnostics phase (precedes the other operations)
- D* No request for heat
- C* Heating
- c* Pump overrun for heating
- d* Domestic hot water
- h* Pump overrun for domestic hot water
- b* Storage cylinder(SYSTEM version)

The right-hand display (two-digit) shows:

- in CENTRAL HEATING mode: temperature of the Central Heating system flow;
- in DOMESTIC HOT WATER mode: temperature of the Domestic Hot Water (MFFI only).

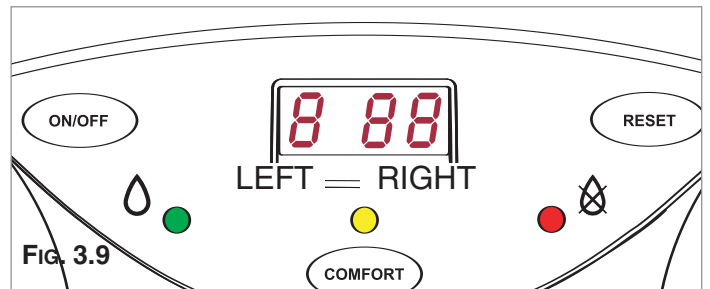

3.6. OPERATING PARAMETERS

The boiler has been designed to allow easy intervention with regard to the operating parameters.

3.6.1 REGULATION MENU TABLE

Summary of the functions accessed when the RESET button (RESET) and the menu button (M) are pushed at the same time for 5 seconds.

On the display will appear the parameters indicated on table 3A. To modify the parameters push the programming keys (-) and (+).

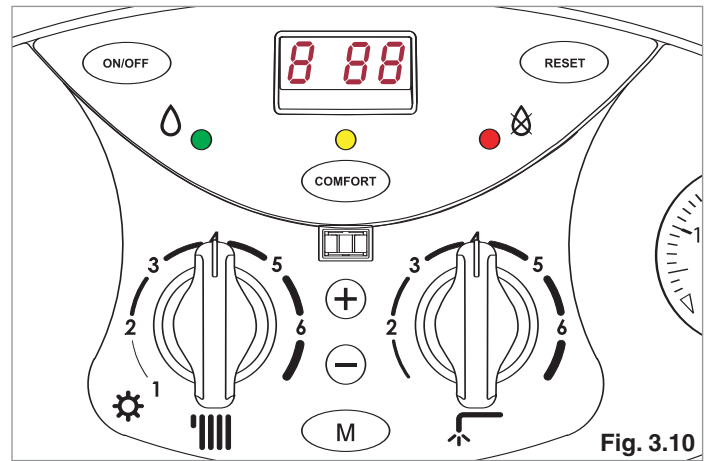



Fig. 3.10

TAB. 3A

left display	right display	function	factory setting
1	from 0 to 99	Soft light as % of maximum Heating Power	60 (ACO 27 MFFI - RFFI SYSTEM) 43 (ACO 32 MFFI - RFFI SYSTEM)
2	from 0 to 99	Maximum Heating Power (%)	55 (ACO 27 MFFI - RFFI SYSTEM) 52 (ACO 32 MFFI - RFFI SYSTEM)
3	from 0 to 7	Ignition delay (minutes)	02
4		Central heating maximum temperature	82
5		Central heating minimum temperature	42
6		PΔT rpm (Check of the temperature difference between the flow and return sensors for twelve seconds on initial start-up)	45
+	from 50 to 51	NOT USED	50
F	from 00 to 02	Boiler types	00 - ACO 27 /32 MFFI 02 - ACO 27/32 RFFI SYSTEM
E	from 00 to 03	Secondary outlet function	00
P	from 01 to 15 or C0	Pump overrun (Central Heating)	02
C	from 00 to 01	Comfort function (only model MFFI)	01
P	from U0 to U1	Pump speed adjustment (modulating or single speed)	U1

left-hand display	right-hand display	Function	factory setting
r	from 00 to 01	selects low temperature systems or std systems	01
P	from 90 to 91	Temperature regulation controlled by external sensor	90
P6	from -20 to +20	Correction of heat curve translation	
P5	from 0_3 to 3_0	Curve incline	
†		Test Function	
R	81	Bus Address (Do not modify)	
b0		Set-point second heating zone	
b1		GSM value	
b	20	NOT USED	
b	30	NOT USED	
b	40	NOT USED	
b	50	NOT USED	
b	60	NOT USED	
b	70	NOT USED	

Important!!
The parameters P5, P6 and P9 are only enabled when the outdoor sensor is connected.

To return to the normal display, press the menu button .

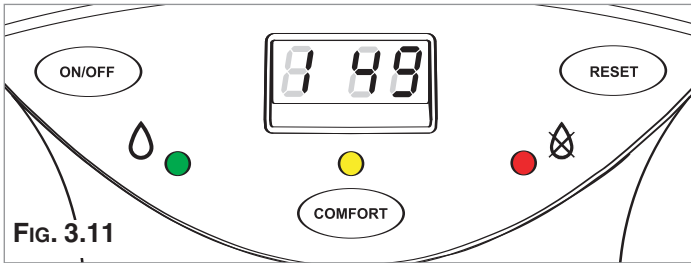

Soft light adjustment 1

The soft light can be adjusted between the maximum power (shown on the display as "00", i.e. 100%) and the minimum power (shown on the display as "01", i.e. 1%). The boiler is factory set to a value which is suitable for the ignition with any type of gas (approx. 33%).

The value set expressed as a percentage, can be displayed and adjusted as indicated in Section 3.6.1 (parameter 1)

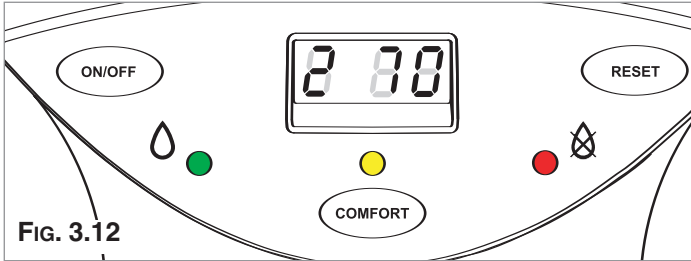

Maximum Heating Power adjustment 2

The maximum heating power can be adjusted to between the maximum power allowed by the boiler (24kW) and the minimum power (8kW). The value is factory set to 70% of the maximum power.

The value set (expressed as a percentage) can be displayed and modified as illustrated in Section 3.6.1 (parameter 2).

The display shows the value between 100% ("00" on the display) and 1% ("01") of this interval.

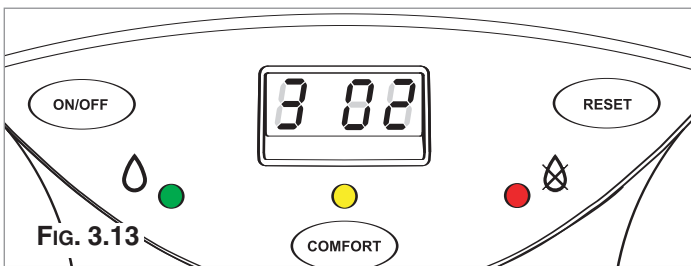
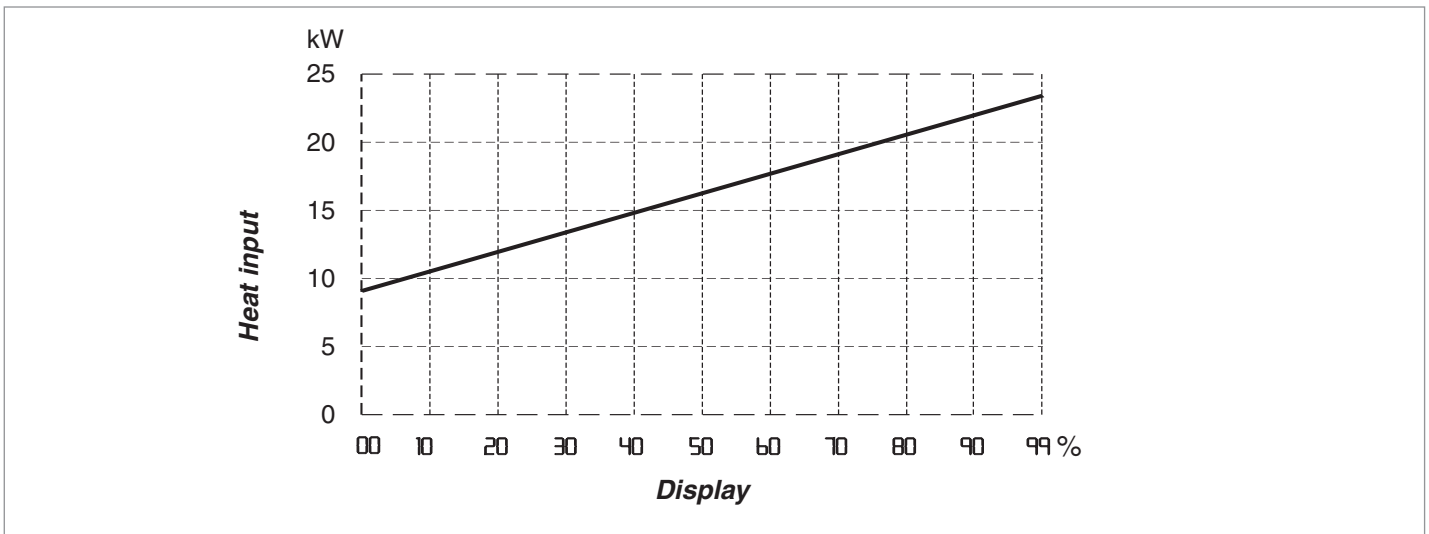

Ignition Delay adjustment 3

The ignition delay can be adjusted to between 0 and 7 minutes. The delay is factory set to 2 minutes.

The value set can be displayed and modified as illustrated in Section 3.6.1 (parameter 3)

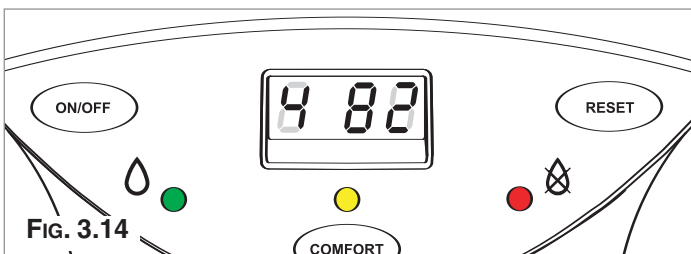

Maximum Central Heating temperature 4

This parameter allows the setting of the maximum temperature for the central heating circuit. The value is factory set at 82°C and can be adjusted as illustrated in Section 3.6.1 (parameter 4).

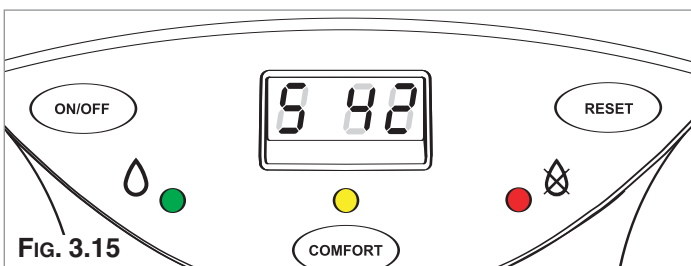

Minimum Central Heating temperature 5

This parameter allows the setting of the minimum temperature for the central heating circuit. The value is factory set at 42°C and can be adjusted as illustrated in Section 3.6.1 (parameter 5).

Boiler types F

Factory setting:

00 - ACO 27 / 32 MFFI (C.H. + D.H.W.)

02 - ACO 27 / 32 RFFI SYSTEM (C.H. only)

THIS PARAMETER MUST NEVER BE ADJUSTED.

Secondary outlet Function E

(This parameter can be modified only with the interface PCB connected)

With the interface PCB connected, it is possible to set the boiler to operate with one of the following accessories, (see Section 2.10 for further information). The setting can be varied by pushing the \oplus and \ominus keys, the following options are available:

00	zone valve - factory setting
01	LPG valve
02	secondary pump
03	NOT USED

PUMP OVERRUN P

The pump overrun may be varied (after the burner has been turned off) by pressing the programming keys \oplus and \ominus .

The following modes are available:

01	1 minute of pump overrun
03	3 minutes of pump overrun - factory setting
06	6 minutes of pump overrun
09	9 minutes of pump overrun
12	12 minutes of pump overrun
15	15 minutes of pump overrun
00	Continuous pump overrun

Comfort Function (MFFI model) C

The boiler allows the convenience level to be increased in the output of domestic hot water by means of the "COMFORT" function. This function keeps the secondary exchanger warm during the periods in which the boiler is inactive, thereby allowing the initial water drawn to be at a higher temperature.

The function may be activated by pressing the **COMFORT** button key on the control panel (see section 3.3.). When the function is active, a yellow light "K" comes on, again located on the control panel.

The comfort function can be activated or deactivated by pressing the \oplus and \ominus keys

00 Comfort function deactivated

01 Comfort function active for 30 minutes - factory setting.

It is possible to deactivate the comfort function by pressing the button **COMFORT**.

The yellow LED "K" will go out.

NOTE: During the overrun period of the pump, the "COMFORT" function, if selected, is temporarily deactivated. The L.E.D. light remains on to indicate that the boiler will return to the "COMFORT" mode once the pump overrun has finished.

Pump Speed Adjustment P

By pressing the \oplus and \ominus keys it is possible to adjust the operation of the pump, the two options are as follows:

U0 - Single Speed Pump

U1 - Modulating Pump - factory setting

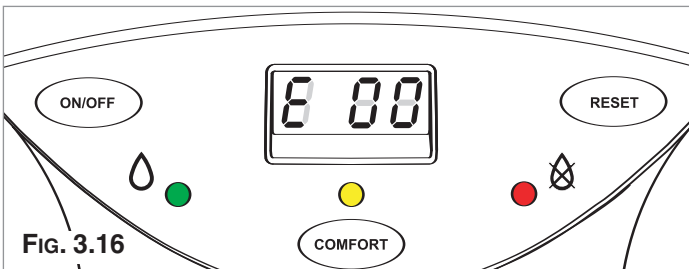

FIG. 3.16

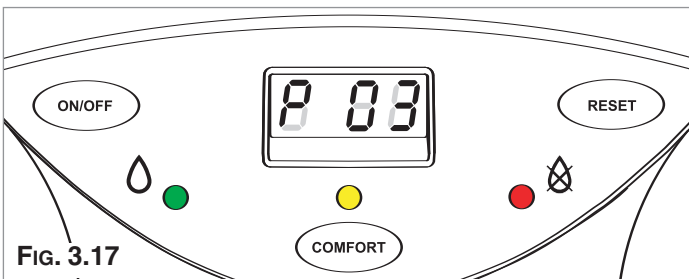

FIG. 3.17

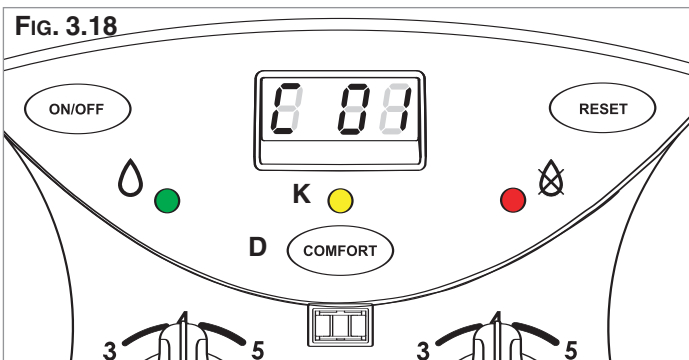

FIG. 3.18

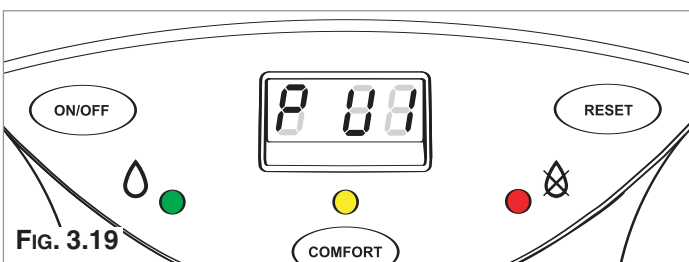
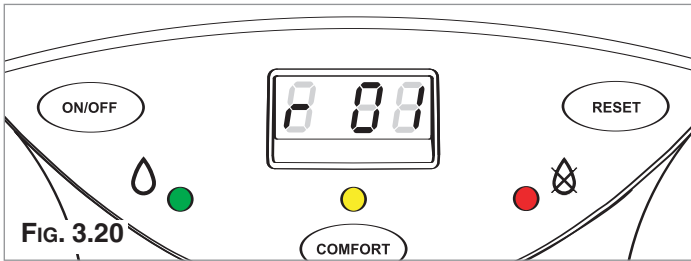

FIG. 3.19



SETTING THE TEMPERATURE FIELD r

Using the programming keys \oplus and \ominus it is possible to make the following adjustments:

“00” signifies that the flow temperature (which may be set by means of the knob on the front control panel) may be regulated from 20 to 75°C.

“01” signifies that the flow temperature (which also may be set by means of the knob on the front control panel) may be regulated from 42 to 82 °C.

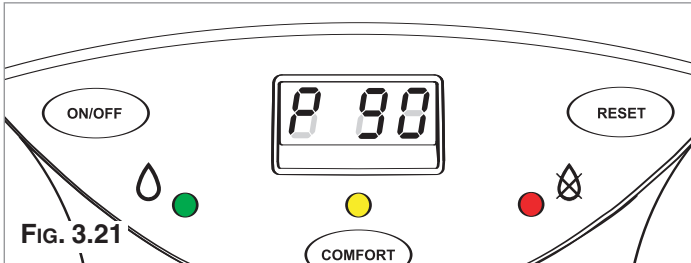

TEMPERATURE REGULATION CONTROLLED BY THE EXTERNAL SENSOR P

(Only enabled when the outdoor sensor is installed)

By pressing the \oplus and \ominus it is possible to make the following adjustments:

“90” Temperature regulation controlled by the external sensor is inactive (not installed).

“91” Temperature regulation controlled by the external sensor is active (installed).

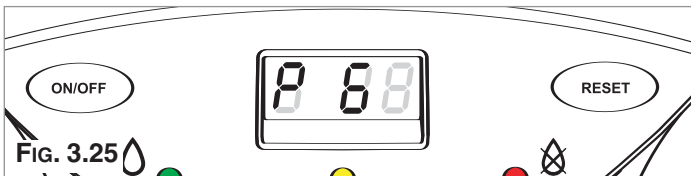

Adapting the heat curve “P 6”

(Only enabled when an outdoor sensor is installed)

To adapt the heat curve to the system requirements, set parameter “P 6” in order to shift the curve in parallel, so that the flow temperature calculated is changed, along with the ambient temperature.

When “P 6” appears on the left-hand display, use the heating control knob to shift the curve in parallel as illustrated in the figure below. The shift value can be read on the right-hand display, from -20 to +20.

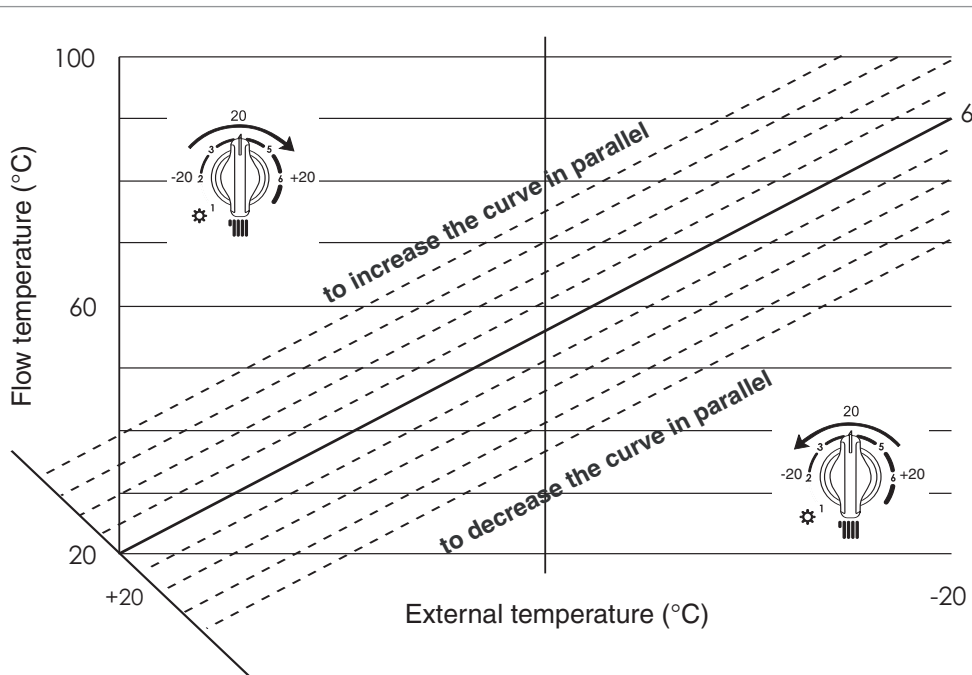
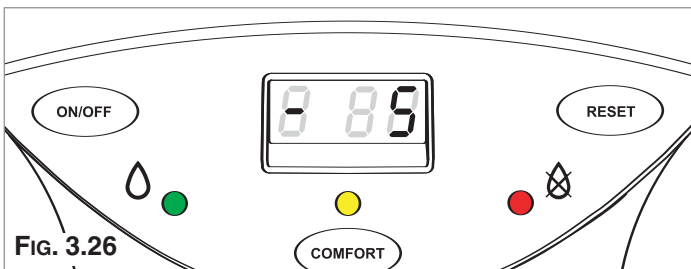

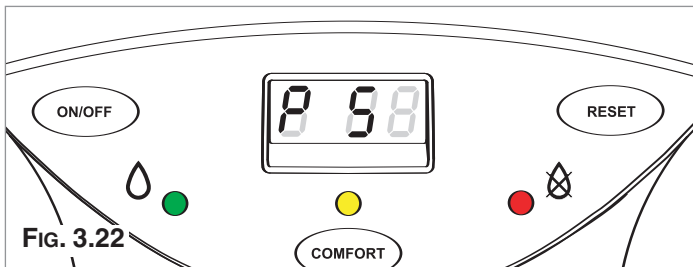

FIG. 3.22

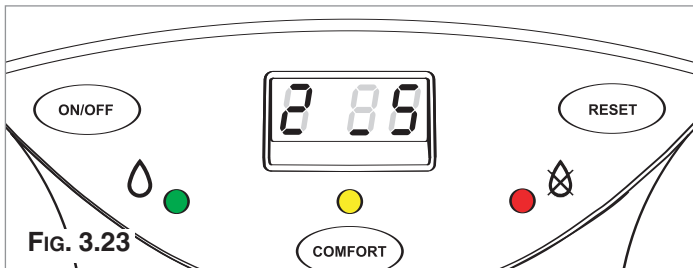

FIG. 3.23

WARNING

(*) - If curve 0_3 or 0_5 is set, a system safety thermostat must be connected to the main terminal board (see paragraph 2.10)

With parameter P 5 it is possible to adjust the heat curve setting to those shown in fig. 4.16). Using programming keys (+) and (-), the curve setting may be changed. The possibility of setting curves varies according to parameter r:

- r = 00 (low temperature range) from curve 0_3 to 0_5 (**underfloor systems only**)
- r = 01 (high temperature range) from curve 1_0 to 3_0.

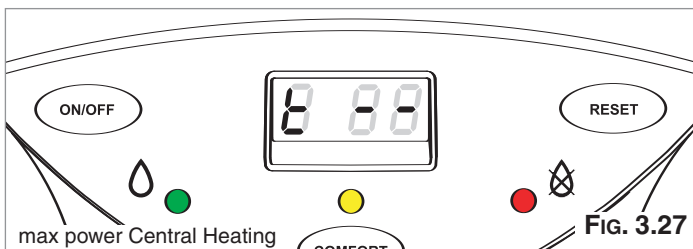

FIG. 3.27

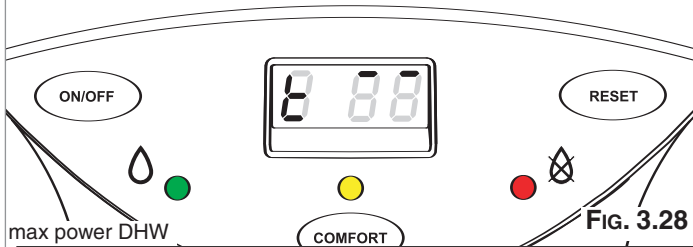

FIG. 3.28

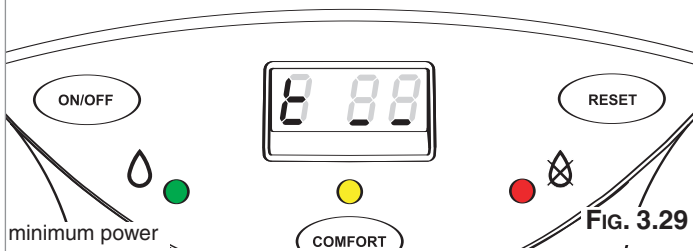

FIG. 3.29

SETTING THE CURVE INCLINE P 5

(Only enabled when an outdoor sensor is installed)

When using an outdoor sensor, the microprocessor-controlled P.C.B. calculates the most suitable flow temperature, taking into account the external temperature and the type of system. The microprocessor is capable of doing this because it is possible to establish a link between the external temperature and the flow temperature of the Central Heating system water. This link translates into a "thermal curve".

The type of curve should be chosen in correspondence with the planned temperature of the system and the nature of the heat loss present in the building.

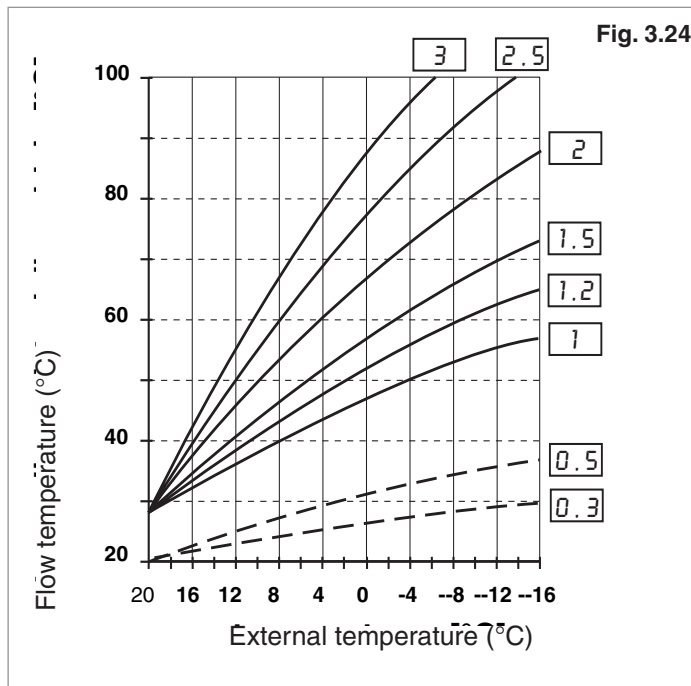

Fig. 3.24

Test Function +

The P.C.B. allows the boiler to be forced to the maximum or minimum power. Enable the test function and t- will appear on the right-hand display (see Fig. 3.8).

To select operation at maximum power, press the programming key (+), two dashes will appear at the top of the right-hand display (see Fig. 3.9).

This function is disabled when you press reset key to quit the adjustments menu.

To select operation at minimum power, press the programming key (-), two dashes will appear at the bottom of the right-hand display (see Fig. 3.10). This function is disabled when you press reset key "H" to quit the adjustments menu.

Note: The boiler can be forced to the maximum and minimum power even without enabling the test function via the adjustments menu:

- a - by pressing the Reset key for 5 seconds, the boiler is automatically forced to test mode and t- will be displayed, the boiler is now in the test mode for the maximum heating power, to force the boiler to maximum output for hot water it is necessary to press the (+) and (-) keys together, two dashes appear at the top of the right-hand display (see Fig. 3.9). This function is disabled by pressing the reset key .
- b - by pressing the (-) key, the boiler is forced to operate at minimum power, two dashes appear at the bottom of the right-hand display (Fig. 3.10). This function is disabled by pressing the reset key.

3.6.2 SETTINGS DISPLAY

The boiler is designed to monitor some operating variables and settings by means of the display on the front control panel. Keeping, at the same time, the reset and the menu key pressed for over 10 seconds will allow access to the "readout" function of the main system variables. By pressing the reset button repeatedly after that, it is possible to read the following information in sequence:

Indication on the left-hand display	Value read on right-hand display
U/1	<i>Flow temperature of the Central Heating circuit (°C)</i>
U/2	<i>Return temperature of the Central Heating circuit (°C)</i>
U/3	<i>Domestic Hot Water output temperature (°C)</i>
U/4	<i>Outdoor temperature (°C)*</i>
U/5	<i>Exhaust Fume temperature</i>
U/6	<i>Fan speed (% rpm)</i>
E	<i>Last safety shut-off (see section 3.7.)</i>
A	<i>Last shutdown (see section 3.7.)</i>

To return to the normal display, press the **menu** key.

The boiler will automatically return to the normal display after no buttons have been pressed for 2 minutes.

NOTE 1: U/1 means that "U" and "1" blink alternately on the display

NOTE 2: the value 100% appears as "00" on the display

* = Only displayed when an external sensor is fitted.

3.6.3 GAS REGULATION CHECK

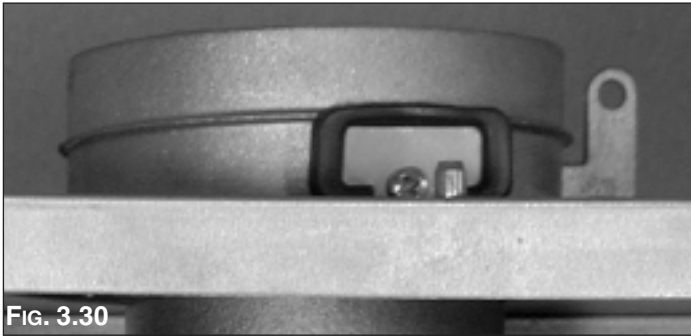

FIG. 3.30

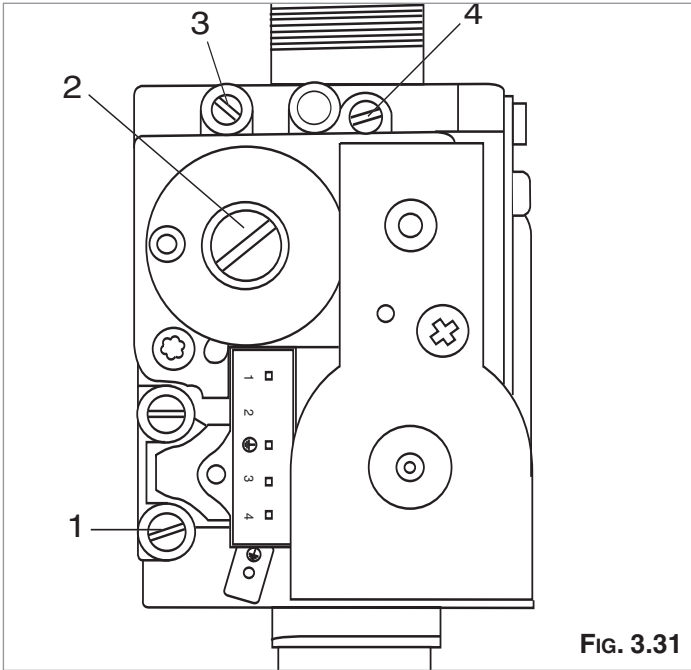

FIG. 3.31

SUPPLY PRESSURE		
G20	methane	17-25 mbar

AIR/GAS RATIO SETTING			
Calibration values check CO ₂ at maximum power after 4 minutes of operation methane G20	% vol	8,7	±0.2

AIR/GAS RATIO SETTING			
Calibration values check CO ₂ at minimum power after 4 minutes of operation methane G20	% vol	9,2	±0.2

Supply pressure check

1. Loosen screw "1" (Fig. 3.31) and connect the pressure gauge connection pipe into the test point.
2. Turn the boiler on at maximum power, enabling the "flue sweep" function (press the RESET key for 5 seconds and press the programming keys + and - together). The supply pressure should correspond to that shown for the type of gas the boiler is designed for methane gas G20.
3. When the check is over, tighten screw "1" and make sure it is securely in place.
4. Disable the test mode by pressing the reset key.

AIR/GAS RATIO CHECK

Air/gas ratio at minimum power

To check the air/gas ratio at minimum power, proceed as follows:

1. Connect the combustion analyser to the analysis point (Fig. 3.30) after removing the cover plate.
2. Turn the boiler on at minimum power via the test function (see paragraph 3.6.1) or by pressing RESET key for 5 seconds and the programming key - on the control panel. Ensure the CO₂ value on the analyser corresponds with the value indicated in table 4D. If this is not the case, adjust screw "2" (Fig.3.31) with a screwdriver, after removing the cap, until you obtain the correct CO₂ reading. Allow the reading to become stable for at least 4 minutes.
3. When the check is over, replace the cap on screw "2" (Fig. 3.31).
4. Disable operation at minimum power by pressing the RESET key.

Air/gas ratio at maximum power

To check the air/gas ratio at maximum power, proceed as follows:

1. With the combustion analyser already connected to the analysis point, set the boiler to maximum power via the test function (see paragraph 3.6.1) or enabling the "flue sweep function" by pressing the RESET key for 5 seconds and the programming keys + and -. Ensure the CO₂ value on the analyser corresponds with the value indicated in table 4D. If this is not the case, adjust screw "4" with a screwdriver (Fig. 3.31), until you obtain the correct CO₂ reading. Allow the reading to become stable for at least 4 minutes.
2. Disable the test mode by pressing the RESET key. The test mode is automatically disabled after 5 minutes.
3. **Repeat the air/gas ratio at minimum power check (see above).**
4. Disconnect the analyser, remount the cover plate and check it is securely in place.

3.6.4 IGNITION DELAY ADJUSTMENT

The ignition delay can be adjusted to between 0 and 7 minutes. The delay is factory set to 2 minutes. The value set can be displayed and modified as illustrated in paragraph 3.6.1 (parameter 3).

3.6.5 ADJUSTING THE MAXIMUM HEATING POWER

The maximum heating power can be adjusted to between the maximum power allowed by the boiler (24 kW) and the minimum one (8 kW). The value is factory set to 70% of the maximum power.

The value set (expressed as a percentage) can be displayed and modified as illustrated in paragraph 3.6.1 (parameter 2).

3.6.6 SOFT LIGHT ADJUSTMENT

The soft light can be adjusted between the maximum power (shown on the display as "00", i.e. 100%) and minimum power (shown on the display as "01", i.e. 1%). The boiler is factory set to a value which is suitable for ignition with any type of gas (approx. 33%).

The value set (expressed as a percentage) can be displayed and modified as illustrated in paragraph 3.6.1 (parameter 1).

3.7 CHANGING THE TYPE OF GAS

Initially the ACO boiler is only available for use with methane Gas (G20).

3.8. BOILER SAFETY SYSTEMS

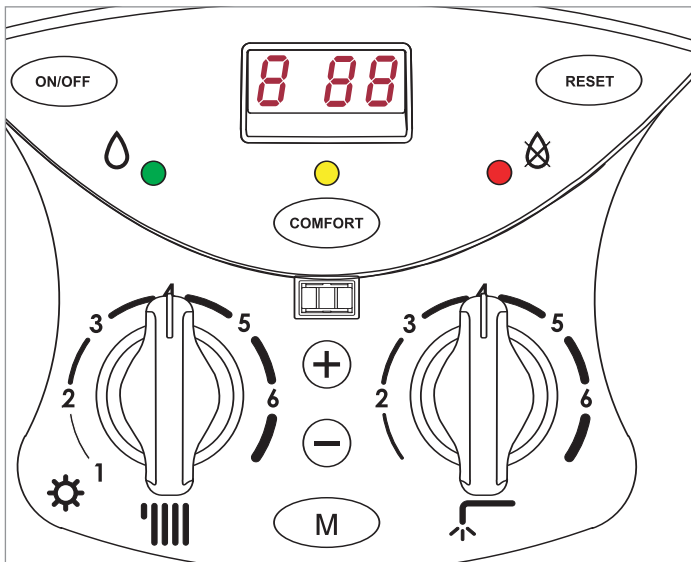

There follows a list of the shutdown modes and the respective codes shown on the display.

Shutdown ("R" type): if such a situation occurs, it is necessary to reset the boiler using the appropriate key. If this shutdown occurs frequently, your local Service Agent should be contacted.

DISPLAY	CAUSE
R01	Too many attempts to ignite on starting up
R02	No water or no water circulation in central heating system
R03	The heating flow temperature exceeds 105°C during operation
R07	Too many failures to flame in one period during operation
R33	Problem with the fan
R97	Problem with the electronic monitoring
R98	Problem with the electronic monitoring
R99	Problem with the electronic monitoring

NOTE: When there is no ignition, check that the gas cock is open.

The boiler is protected from malfunctioning by means of internal checks by the P.C.B., which brings the boiler to a stop if necessary.

In the event of the boiler being shut off in this manner, a code appears on the display which refers to the type of shut-off and the reason behind it.

There are two types of shut-off:

- **SAFETY SHUTDOWN:** for this group of errors (characterised on the display by the letter "E") the situation is automatically removed as soon as the cause behind it is resolved. As soon as the origin of the shutdown disappears, the boiler starts up again and returns to its normal operation.
- **SHUTDOWN:** (characterised on the display by the letter "R"), is not removed unless a manual intervention is made. The boiler may return to operation only if reset by pressing the RESET button located at the centre of the display.

Safety shutdown: In the event that a safety shutdown occurs, it is necessary to contact an Authorised Service Centre.

DISPLAY	CAUSE
E 04	Domestic hot water temperature probe in open circuit
E 05	Domestic hot water temperature probe in short circuit
E 06	Heating flow temperature probe in open circuit
E 07	Heating flow temperature probe in short-circuit
E 08	Heating return temperature probe in open circuit
E 09	Heating return temperature probe in short-circuit
E 10	Under floor heating temperature probe in open circuit
E 20	Flame detected with gas valve closed
E 30	Outdoor sensor open circuit
E 31	Outdoor sensor in short circuit
E 33	Fan operation sensed with no demand for central heating or domestic hot water
E 34	Fan operation but air pressure switch does not close
E 80	Remote Control CLIMA MANAGER room sensor in open circuit or short circuit
E 94	Problem within the electronic system
E 95	Error reading flow or return temperature probe
E 99	Problem within the electronic system

DAILY TEST.

In order to prevent the shutdown of the components, the boiler carries out a self-diagnosing test every 21 hours: the pump turns on for 15 seconds and the diverter valve moves.

ANTI-FROST DEVICE.

The anti-frost function acts on the central heating flow temperature probe, independently from other regulations, when the board is turned ON.

If the primary circuit temperature falls below 8°C the pump will run for 2 minutes.

After the two minutes of circulation (fixed) the boiler will check the following:

- a) if the central heating flow temperature is > 8°C, the pump stops;
- b) if the central heating flow temperature is between 3 and 8°C, the pump will run for another two minutes;
- c) if the central heating flow temperature is < 3°C, the burner will fire (heating position) at minimum power until the temperature reaches 33°C, the burner will go out and the pump will continue to run for two minutes.

3.9. COMBUSTION ANALYSIS

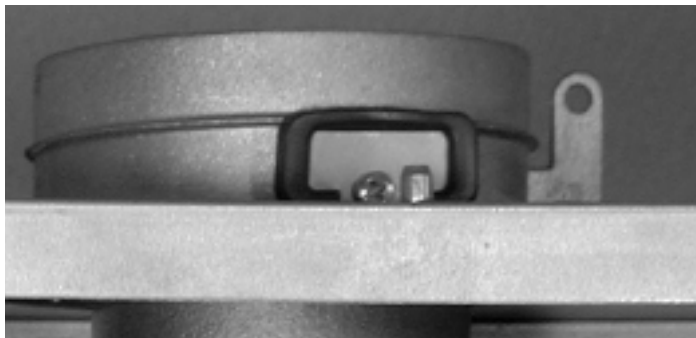

If the flow temperature remains between 3-8°C the pump will continue to run for two minutes for a maximum of 10 times unless a temperature above 8°C is detected in the central heating flow, after this the burner will fire.

If lockout is caused by overheat the burner is kept OFF.

NOTE: In all cases, the circulation takes place in the central heating system.

The anti-frost device activates only when (with the boiler operating correctly):

- the system pressure is correct;
- the boiler is electrically powered;
- there is a supply of gas.

ANTI-SCALE DEVICE.

When producing domestic hot water, the burner shuts off whenever the output temperature of the hot water exceeds 61°C or the flow temperature of the primary circuit exceeds 78°C. It will not turn on if the temperature of the primary circuit is greater than 78°C.

The boiler is designed to allow for easy analysis of the products of combustion.

Using the flue analysis points, it is possible to detect the temperature of the burnt gas, the combustion air, the concentrations of O₂, CO₂, etc.

To access these points, unscrew the front screw and remove the metal plate and seal.

The best test conditions, with the maximum heating power, are achieved when the FLUE SWEEP FUNCTION is enabled (press the RESET KEY for 5 seconds and the programming keys + and -). The boiler will return to normal operating conditions automatically after 5 minutes, or if you press the reset key. When you have finished, reposition the metal plate correctly and make sure the seal fits perfectly.

3.10 COMPLETION

For the Republic of Ireland it is necessary to complete a "Declaration of Conformity" to indicate compliance to I.S. 813. An example of this is given in the current edition of I.S. 813. In addition it is necessary to complete the *benchmark* Log Book.

3.11 DRAINING

The draining of the heating system must be carried out as follows:

- Turn off the boiler and the bipolar switch;
- Loosen the automatic air release valve;
- Open the system's discharge valve and gather the water that comes out in a container;
- Empty out from the lowest points of the system (where provided).

If the system is to be left active in areas where the room temperature may go below 0°C during winter, it is recommended that anti-freeze liquid be added to the water in the heating system in order to avoid the need for repeated draining.

Draining the domestic hot water system

Every time that there is a danger of freezing, the domestic hot water system must be drained as follows:

- close the water mains stop-cock;
- open all the hot and cold water outlets;
- empty out from the lowest points (where provided).

4. ZONE VALVES

The boiler is capable of managing a heating system that uses zone valves. The electrical connection of these valves is carried out by means of the appropriate terminal board (indicated in the "ELECTRICAL CONNECTION" section).

By way of example, two possible types of systems would be:

1. System with 2 valves with independent regulation of the zones (day and night).
2. System with 1 valve (regulation of the night zone subordinated to that of the day).

A possible set-up for the first type of system is as follows:

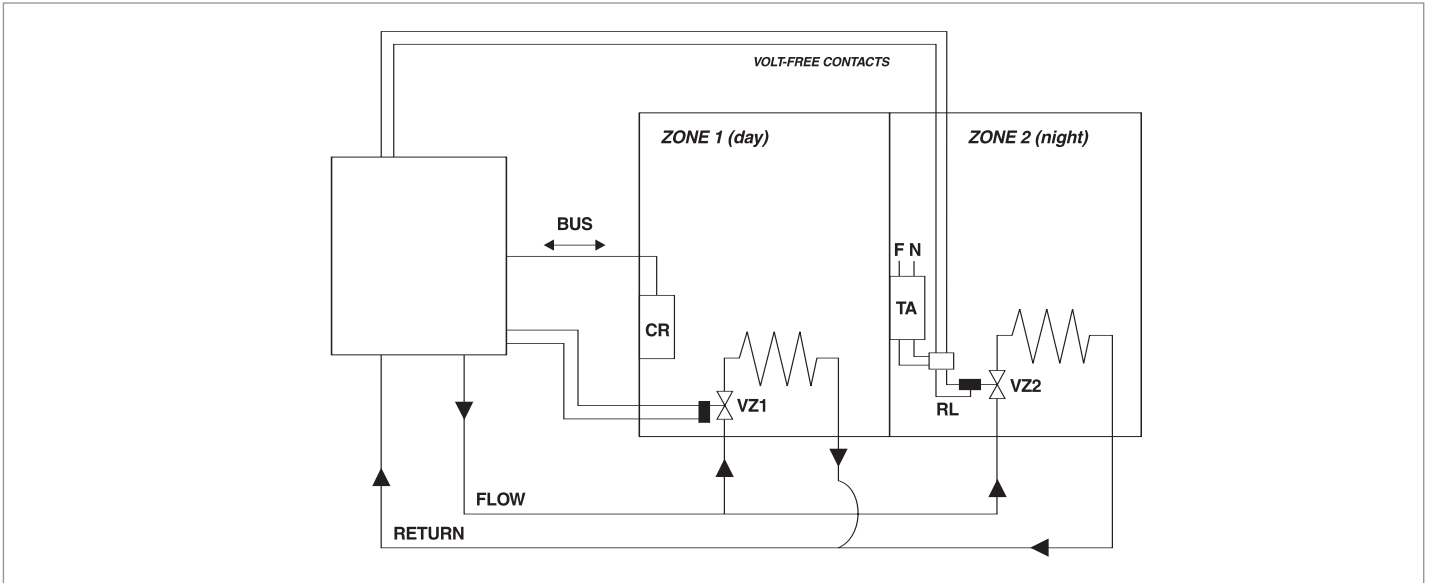

- CR = remote control
- VZ1,2 = zone valve 1 and 2
- TA = room thermostat or timer-thermostat
- ~ = radiators
- F,N = electrical connection (live and neutral)
- RL = relay

A possible set-up for the system with a single zone valve is as follows:

This set-up is simpler and more economical because it does not involve the use of the special relay. The night zone, however, may only be heated during the time periods in which the remote control timer gives consent to the heating of the day zone. Example:

- day zone programming (remote control): 8:00 - 22:00
- night zone programming (timer-thermostat): 20:00 - 22:00

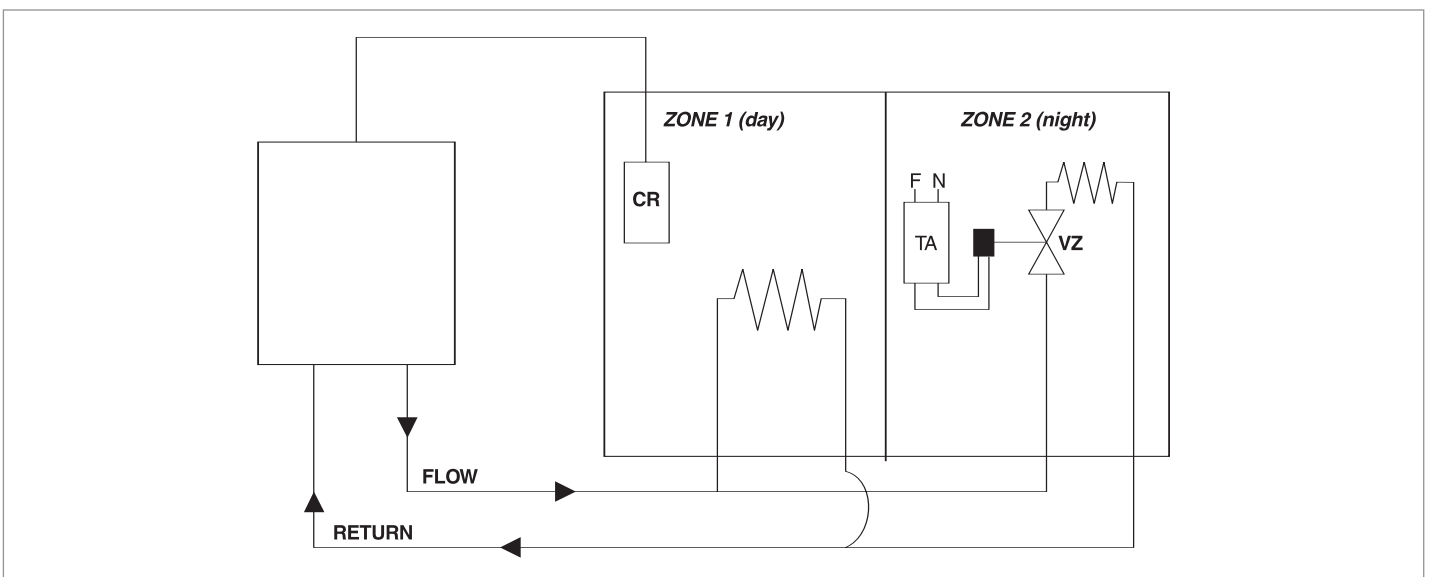

5. MAINTENANCE

5.1. GENERAL REMARKS

IMPORTANT!!

Every time that the combustion chamber cover or the primary heat exchanger is removed from the boiler, the combustion chamber seal must be replaced (code: 65102217). The silicone grease provided with the gasket must be spread around the area the gasket fits to ensure an airtight seal.

Only the grease provided must be used, however, should more grease be needed it must have a temperature range of between -40 deg C and $+200$ deg C”

5.2. CLEANING THE PRIMARY EXCHANGER

IMPORTANT!!

Every time that the combustion chamber cover or the primary heat exchanger is removed from the boiler, the combustion chamber seal must be replaced (code: 65102217). The silicone grease provided with the gasket must be spread around the area the gasket fits to ensure an airtight seal.

Only the grease provided must be used, however, should more grease be needed it must have a temperature range of between -40 deg C and $+200$ deg C”

5.3. CLEANING THE CONDENSATE TRAP

NB: if the boiler is not to be used for a prolonged period, the condensate trap should be filled before igniting it again. A shortage of water in the trap is dangerous because there is the risk of exhaust fumes escaping into the air.

5.4. OPERATIONAL TEST

It is recommended that the following inspections be carried out on the boiler at least once a year:

1. Check the seals in the water group and, if necessary, replace the gaskets and restore the seal to perfect working order.
2. Check the seals in the gas group and, if necessary, replace the gaskets and restore the seal to perfect working order.
3. Visually check the overall state of the boiler.
4. Visually check the combustion and, if necessary, disassemble and clean the burner.
5. Following inspection 3, disassemble and clean the combustion chamber, if necessary.
6. Following inspection 4, disassemble and clean the injector, if necessary.
7. Clean the primary heat exchanger (see section 6.2)
8. Regulate the correct rate of flow of the gas: rate of flow on ignition, partially loaded and at maximum load.
9. Check the correct functioning of the heating safety devices:
 - temperature limit safety device.
10. Check the correct functioning of the gas group safety devices:
 - absence of gas or flame safety device (Ionisation).
11. Check that the electrical connections are correct (in conformity with the instructions manual).
12. Check the efficiency of the production of domestic hot water (test the rate of flow and temperature).
13. Carry out a general inspection of the functioning of the boiler.
14. Check the characteristics for expulsion of the products of combustion.
15. Remove the oxide from the detection electrode by means of an emery cloth.

CLEANING THE EXHAUST SIDE

Remove the combustion chamber inspection hatch (see section 6.3.5). Check that the exhaust passages between the blades of the block are free; if there are deposits present, wash the blades with compressed air, water or a vinegar-based detergent.

NOTE: it is possible to use a brush in order to mechanically remove the residues.

Use of detergents:

- soak the blades well
- allow the detergent to act for about 20 minutes
- rinse with a strong jet of water to remove the deposits (the control panel must be kept closed)
- make sure that there are no traces of detergents in the exchanger.

CLEANING THE WATER SIDE

Use detergents that dissolve CaCO_3 . Leave to act for a short time (in order not to damage the aluminum) and then rinse. Make sure that the detergent does not remain inside the exchanger.

Unscrew the lower part of the condensate trap and clean it. Lastly, fill it with water and replace the stopper.

After having carried out the maintenance operations, fill the heating circuit to a pressure of approx. 1.5 bar and release the air from the system. Also fill the domestic hot water system.

- Place the boiler in operation.
- If necessary, release the air again from the heating system.
- Check the settings and the correct functioning of all the control, regulation and monitoring parts.
- Check the seal and the correct functioning of the system for expelling fumes/drawing of combustion air.
- Check that the boiler ignites properly and carry out a visual check on the burner flame.

7. FAULT FINDING

7.1. FAULT FINDING GUIDE (FLOW-CHARTS)

It is possible to detect and correct any defect by using the standard fault finding diagrams described in this chapter.

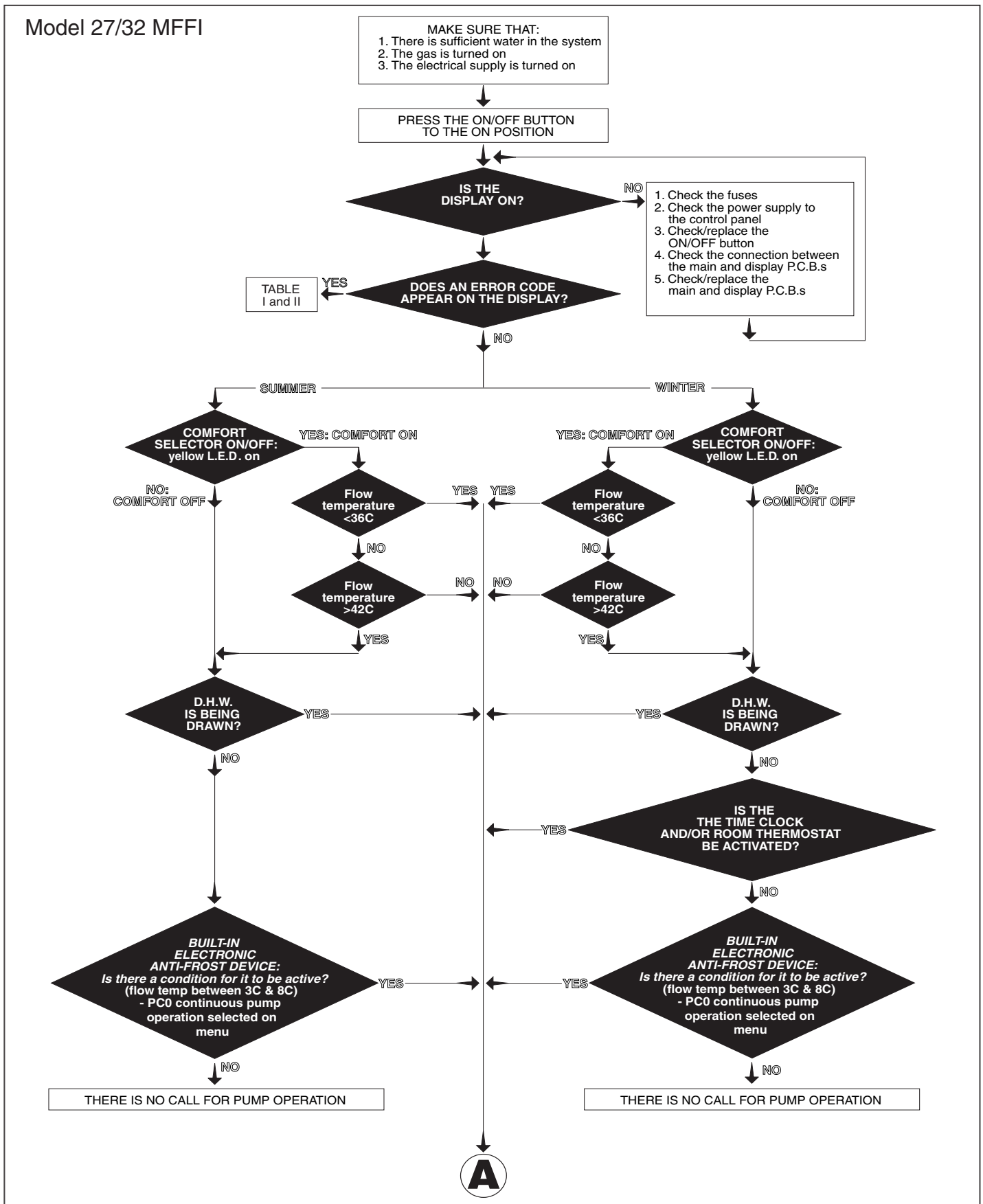

Model 27/32 RFFI SYSTEM

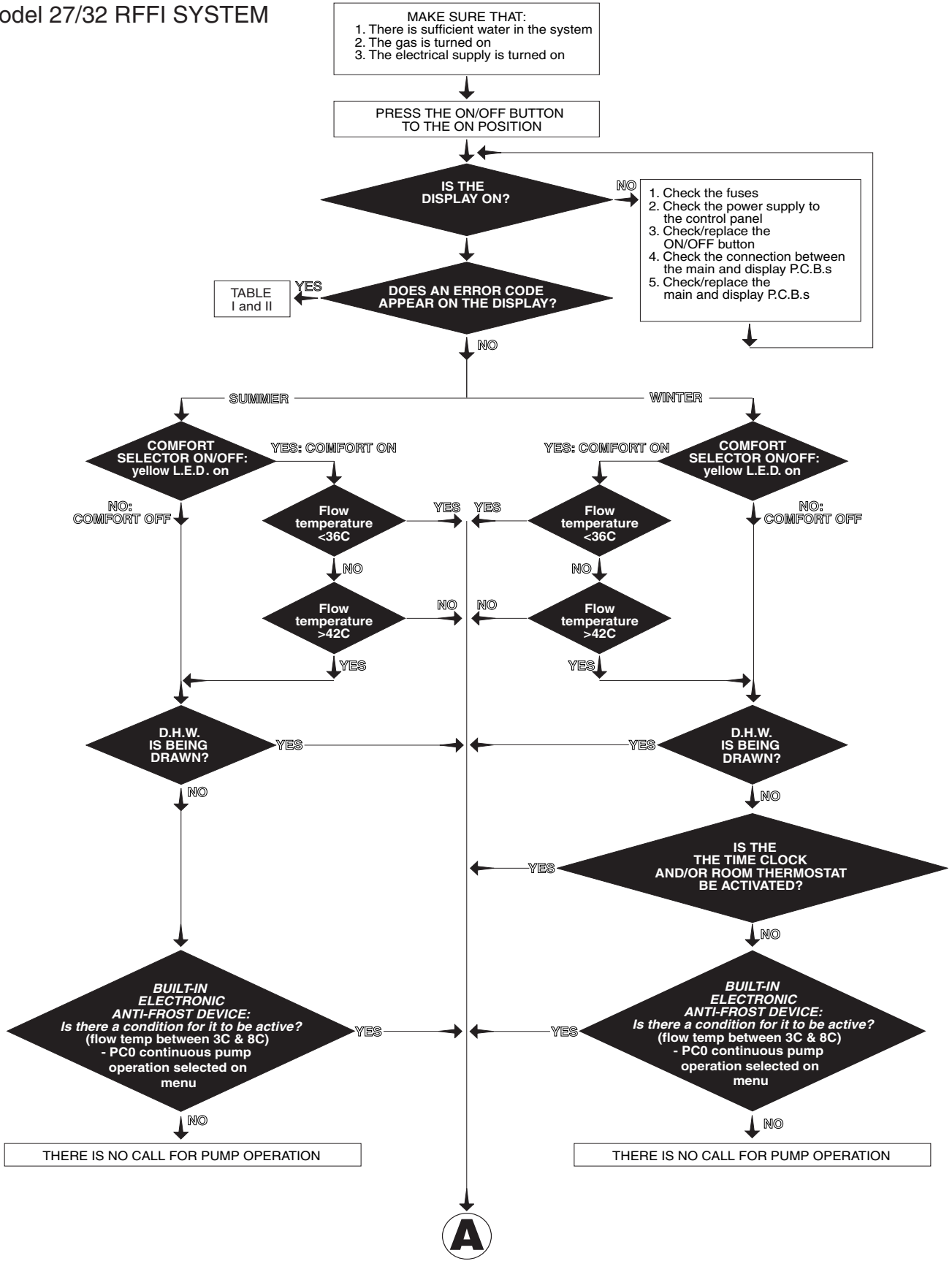

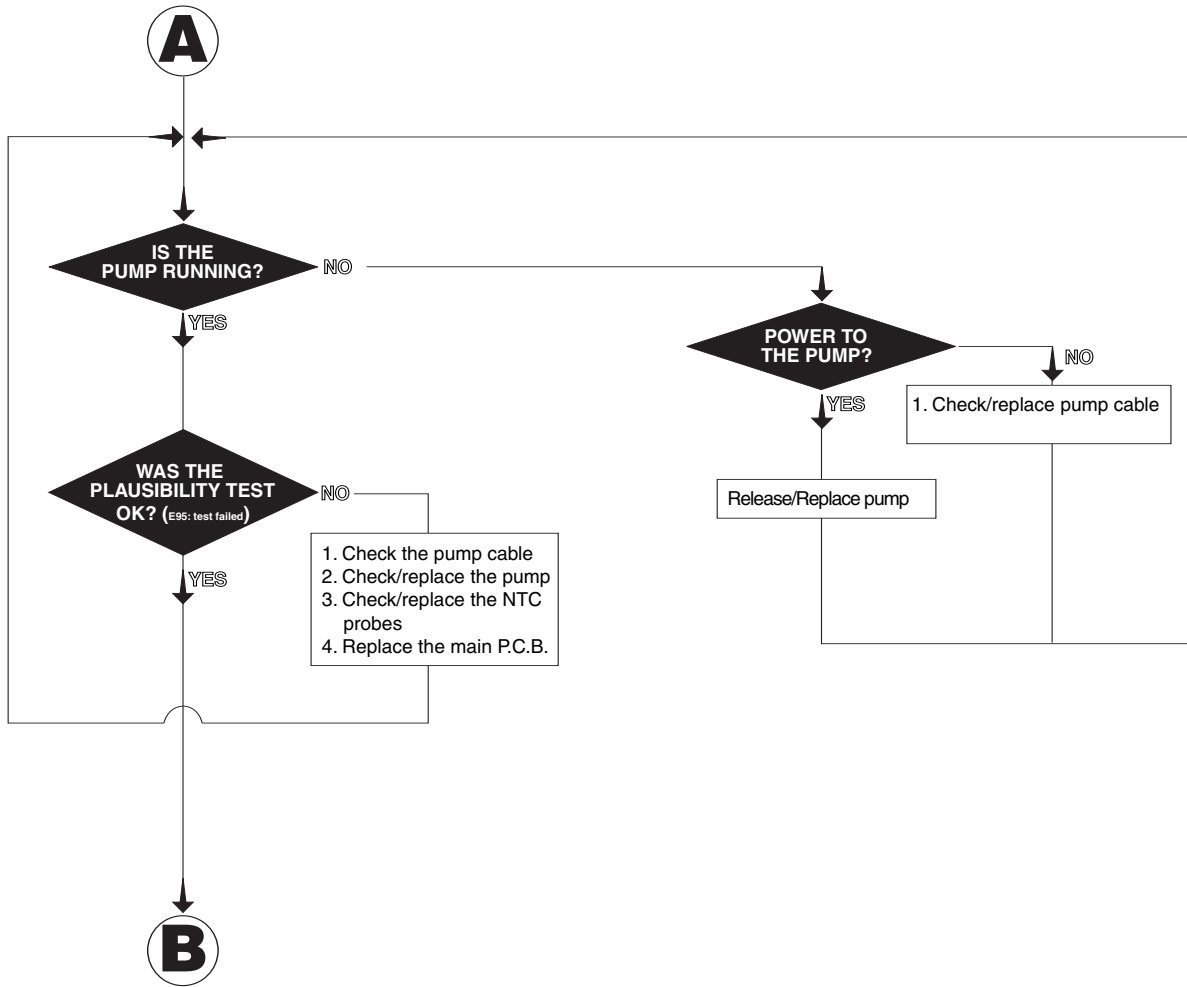

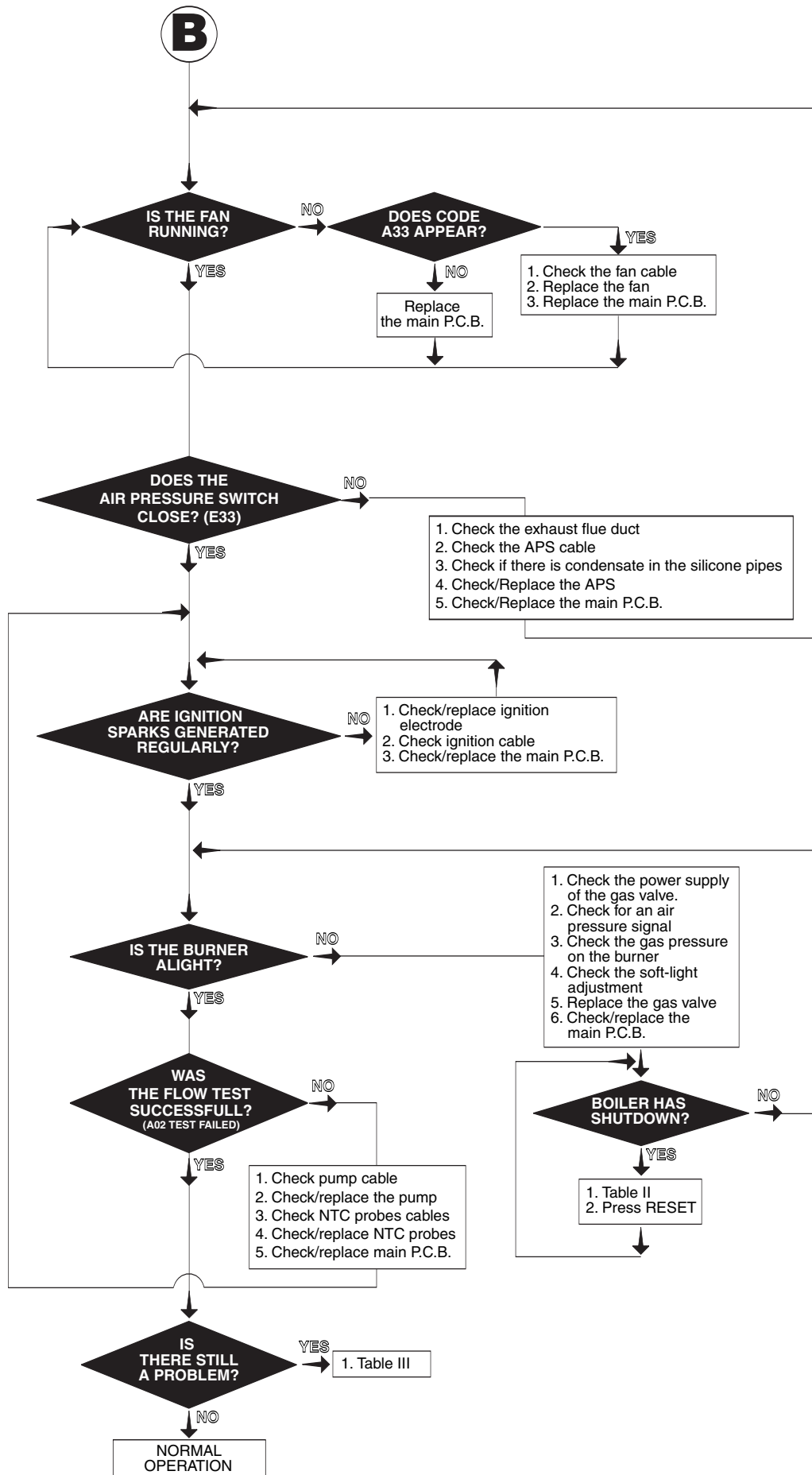

8. SHORT SPARE PART LIST

ACO 27/32 MFFI

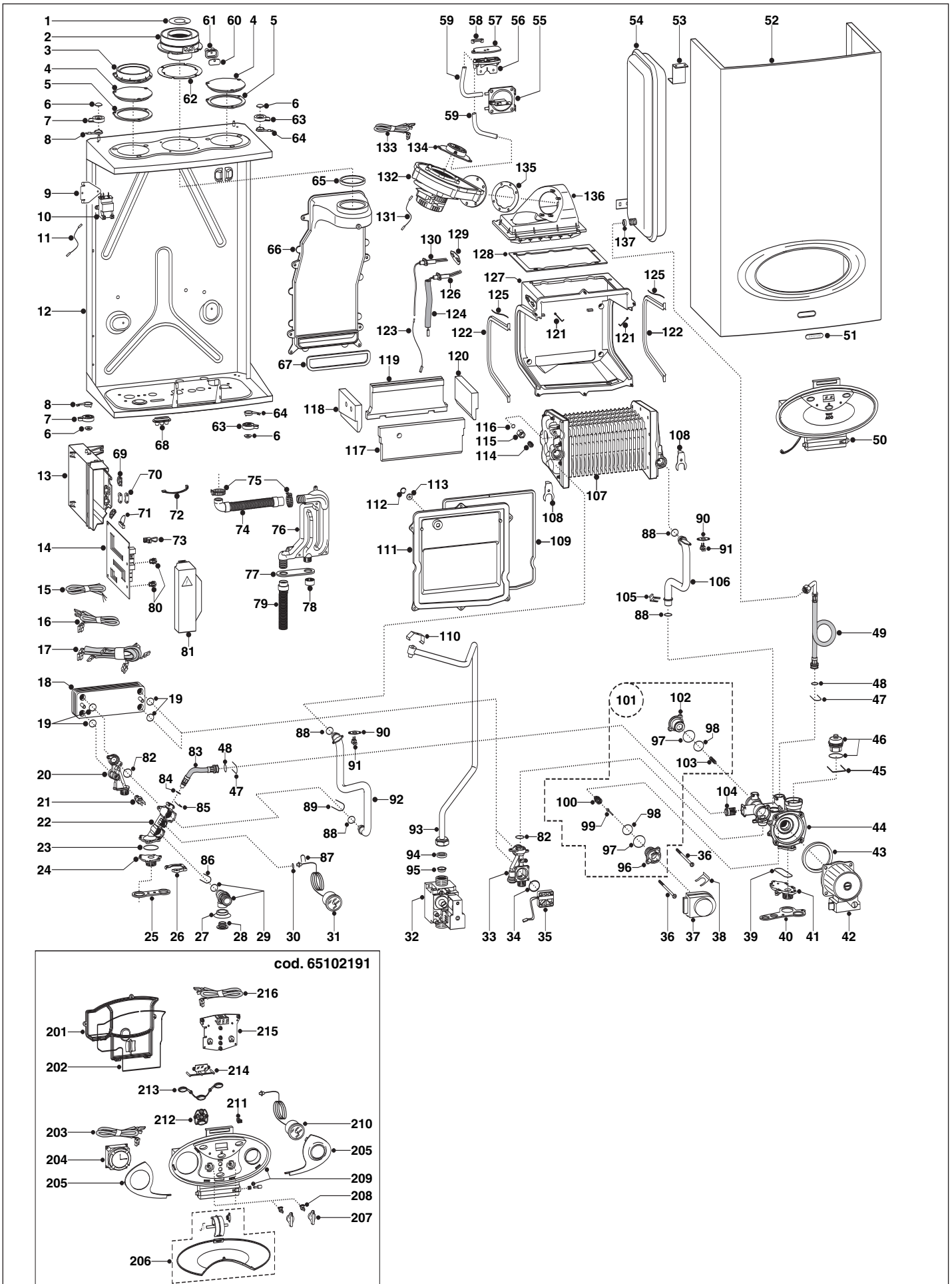

Key no.	G.C. part no.	Description	ARISTON Part. No.
1		Flue restrictor	65102197
10		Spark generator	65102177
14		Main P.C.B.	65102236
18		Secondary heat exchanger	990685
21		Temperature probe (DHW)	998458
22		Manifold (CH Return)	990384
29		Safety valve (3bar)	997088
31		Pressure gauge	65102220
32		Gas valve	65102247
35		Flow switch (DHW)	995948
37		Motor (3-way valve)	997147
42		Pump	65102253
46		Automatic air vent	995865
54		Expansion vessel	995940
55		Air pressure switch	65102232
75		Hose clip	990632
90		Retaining clip (NTC CH)	65101007
91		NTC (CH)	990405
101		Repair kit (3-way valve)	65101288
107		Main exchanger (27 KW)	65102233
107		Main exchanger (32 KW)	65102260
126		Ignition electrode	65102198
130		Detection electrode	65102199
132		Fan	65102248
136		Burner (27kW)	65102181
136		Burner (32kW)	65102180
203		Cable (Time Clock)	65102188
204		Time Clock	999599
215		Display P.C.B.	65102235
216		Cable (Display P.C.B.)	65102185

ACO 27/32 RFFI SYSTEM

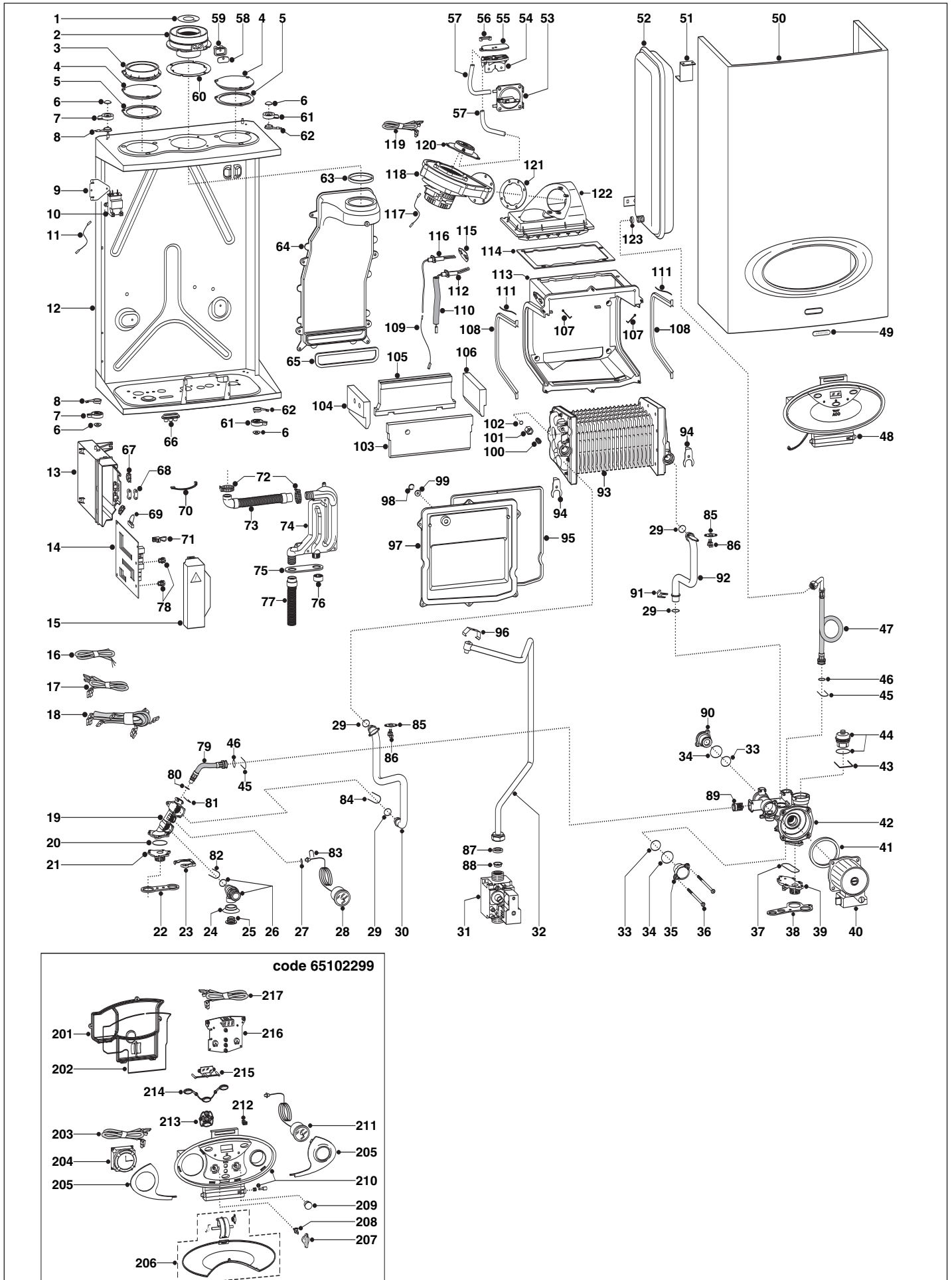

Key no.	G.C. part no.	Description	ARISTON Part. No.
1		Flue restrictor	65102196
10		Spark generator	65102177
14		Main P.C.B.	65102236
42		Manifold (CH Return)	65102305
26		Safety valve (3bar)	997088
28		Pressure gauge	65102220
31		Gas valve	65102247
40		Pump	65102253
44		Automatic air vent	995865
52		Expansion vessel	995940
53		Air pressure switch	65102232
75		Hose clip	990632
85		Retaining clip (NTC CH)	65101007
86		NTC (CH)	990405
93		Main exchanger (27 KW)	65102233
93		Main exchanger (32 KW)	65102260
112		Ignition electrode	65102198
116		Detection electrode	65102199
118		Fan	65102248
122		Burner (27kW)	65102181
122		Burner (32kW)	65102180
203		Cable (Time Clock)	65102188
204		Time Clock	999599
216		Display P.C.B.	65102235
217		Cable (Display P.C.B.)	65102185

Manufacturer: **Merloni TermoSanitari SpA - Italy**

Commercial subsidiaries: **MTS (GB) LIMITED**
MTS Building
Hughenden Avenue
High Wycombe
Bucks HP13 5FT
Telephone: (01494) 755600
Fax: (01494) 459775
Internet: www.mtsgroup.com/uk
E-mail: info@uk.mtsgroup.com
Technical Advice: 0870 241 8180
Customer Service: 0870 600 9888

MTS Heating Limited
Damastown Industrial Park
Damastown Avenue
Mulhuddart
Dublin 15
Telephone: (01) 810 3723
Fax: (01) 810 3727
Internet: www.mtsgroup.com/ie
E-mail: info@ie.mtsgroup.com
Technical Advice: (01) 437 0121
Customer Service: (01) 437 0121